

SCN

Slam shut valves



TECHNICAL BROCHURE

Pietro Fiorentini S.p.A.

Via E.Fermi, 8/10 | 36057 Arcugnano, Italy | +39 0444 968 511
sales@fiorentini.com

The data are not binding. We reserve the right
to make changes without prior notice.

scn_technicalbrochure_ENG_revB

www.fiorentini.com

Who we are

We are a global organization specialized in designing and manufacturing technologically advanced solutions for natural gas treatment, transmission and distribution systems.

We are the ideal partner for operators in the Oil & Gas sector, with a business offer that goes across the whole natural gas chain.

We are in constant evolution to meet our customers' highest expectations in terms of quality and reliability.

Our aim is to be a step ahead of the competition, with customized technologies and an after-sale service program undertaken with the highest grade of professionalism.



Pietro Fiorentini advantages



Localised technical support



Experience since 1940



We operate in over 100 countries

Area of Application

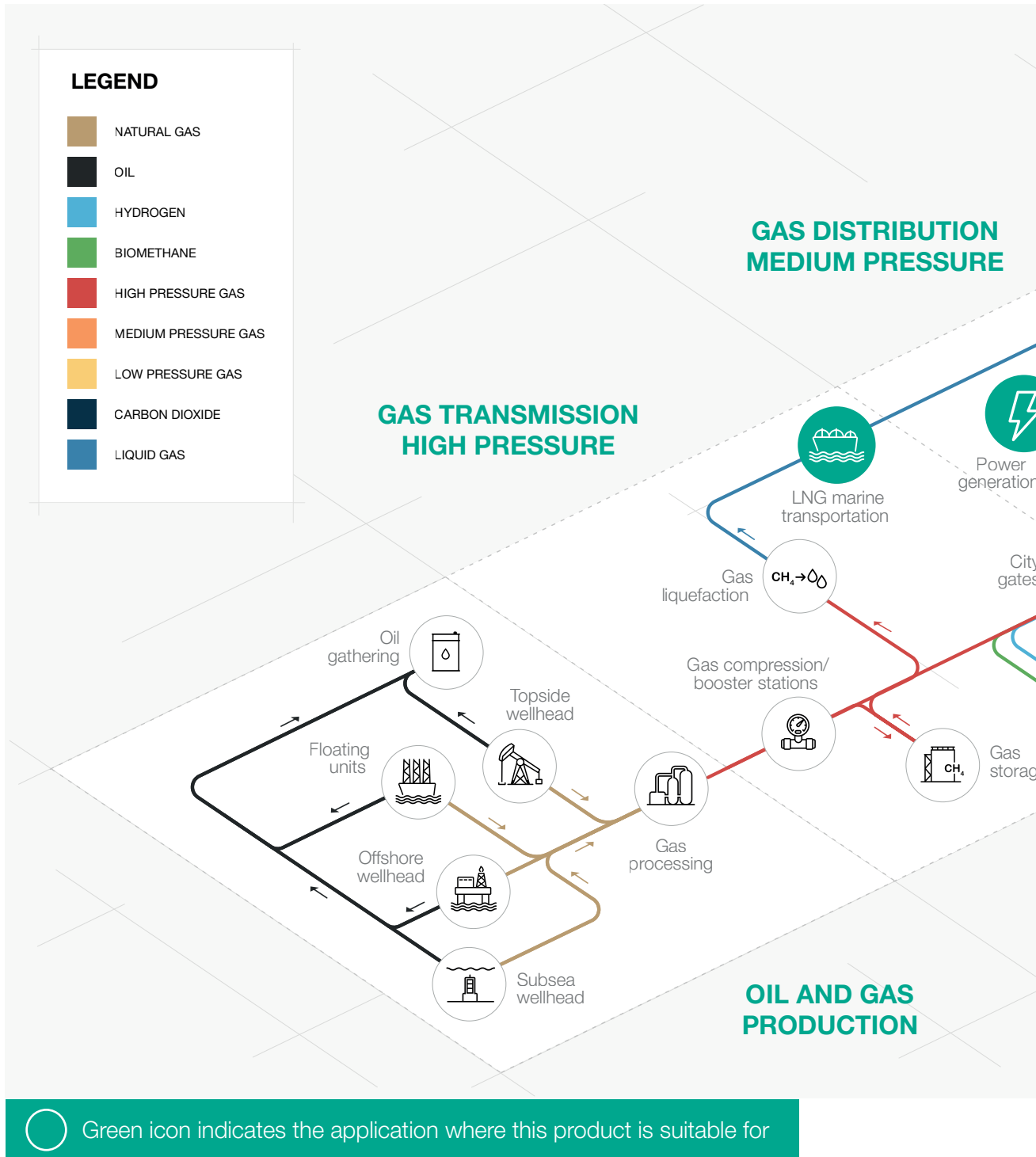

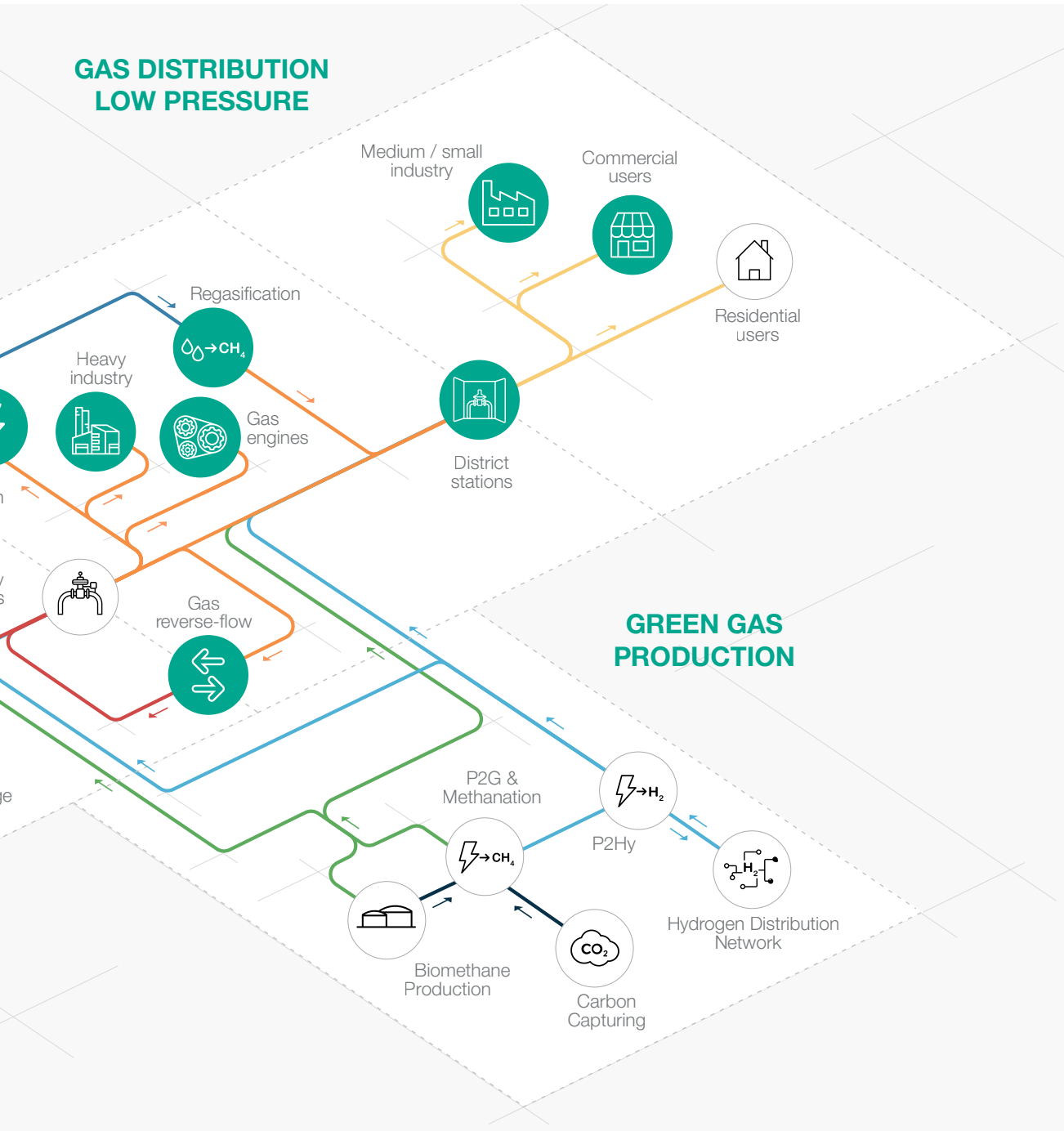

Figure 1 Area of Application Map



Introduction

SCN is a safety device, also called slam shut valve, suitable to quickly interrupt the gas flow when the pressure reaches a calibration set value.

This device is mainly used in medium and low pressure gas distribution networks.

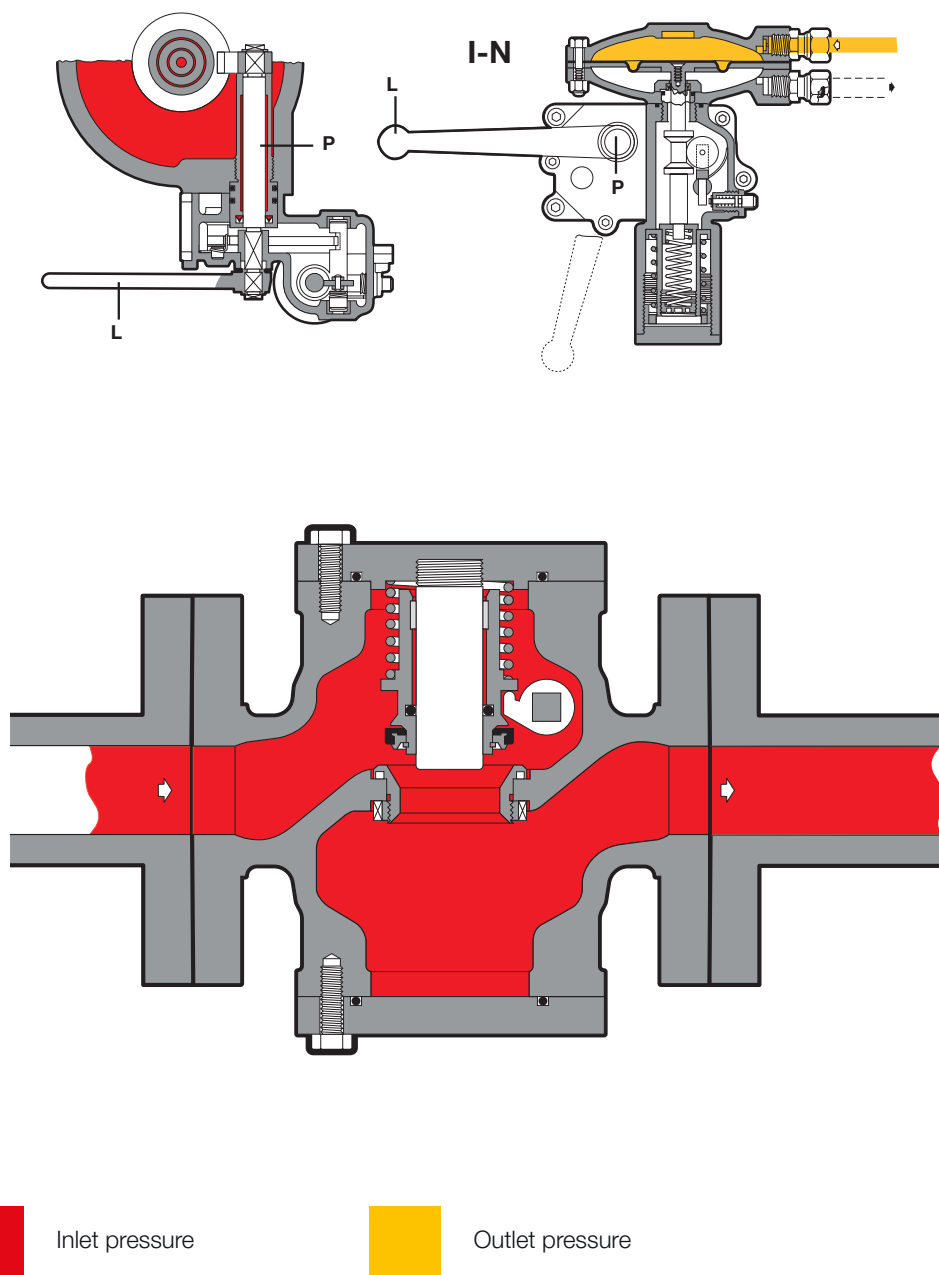

Figure 2 SCN

Features and Calibration ranges

A key feature of a slam shut valves is to be **extremely fast in response time**, ensuring the tripping within 1 second. Set point adjustment of the slam shut is operated via a pressostatic device which is sensing the downstream pressure.

The tripping of the slam-shut device, besides occurring **automatically** when the predetermined set-point is exceeded, it can also be enabled by pressing the local push button available on the pressure switch, or remotely.

As a result of the tripping of the slam-shut valve, the subsequent restoration of the normal operating condition, also called **RESET** operation, is carried out in a **purely manual manner**, after having verified and solved the causes that led to such a tripping.

This slam shut valve is suitable to be used with previously filtered, non corrosive gases, in natural gas distribution networks as well as high load industrial application.

It is a **truly top entry design** which allows an **easy maintenance** of parts directly in the field **without removing the body from the pipework**.

The modular design of SCN slam shut valve series allows its retrofitting on existing pressure regulators in the field without piping modifications.

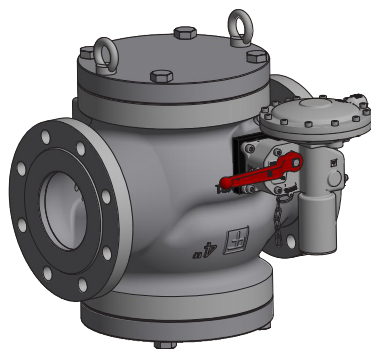











Figure 3 SCN

SCN competitive advantages

-  Over Pressure Shut-Off
-  Under Pressure Shut-Off
-  Internal by-pass
-  Push button for tripping test
-  Top Entry
-  Compact dimensions
-  Easy maintenance
-  Remote tripping option
-  Limit switch option
-  Biomethane compatible and 20% Hydrogen blending compatible. Higher blending available on request

Features

Features	Values
Design pressure*	up to 1.6 MPa up to 16 bar
Ambient temperature*	from -20 °C to +60 °C from -4 °F to +140 °F
Inlet gas temperature range*	from -20 °C to +60 °C from -4 °F to +140 °F
Available Accessories	Limit switch, remote tripping
Accuracy class AG	up to 2.5 for OPSO (depending on working conditions) up to 5 for UPSO (depending on working conditions)
Over pressure setting range (OPSO)	from 0.0025 MPa to 0.5 MPa from 0.025 barg to 5 barg
Under pressure setting range (UPSO)	from 0.001 MPa to 0.3 MPa from 0.01 barg to 3 barg
Nominal dimensions DN	DN 25 / 1"; DN 40 / 1" 1/2; DN 50 / 2"; DN 65 / 2" 1/2; DN 80 / 3"; DN 100 / 4"; DN 150 / 6"; DN 200 / 8";
Connections*	Class 150 RF according to ASME B16.5 and PN16 according to ISO 7005
End to end dimensions	EN 14382

(*) REMARK: Different functional features and/or extended temperature ranges available on request. Stated temperature ranges are the maximum for which the equipment's full performance, including accuracy, are fulfilled. Standard product may have a narrower range.

Table 1 Features

Materials and Approvals

Part	Material
Body	Cast steel ASTM A 216 WCB (all DN). Spheroidal ductile iron GS 400 – 18 ISO 1083 DN 150 (6") included.
Stem guide	AISI 416
Plug	AISI 416 + TN028
Valve seat	AISI 420
Sealing ring	Nitrile rubber
Compression fittings	According to DIN 2353 in zinc-plated carbon steel. Stainless steel on request

REMARK: The materials indicated above refer to the standard models. Different materials can be provided according to specific needs.

Table 2 Materials

Construction Standards and Approvals

SCN slam shut valve is designed according to the European standard EN 14382.

The product is certified according to European Directive 2014/68/EU (PED).

Leakage class: bubble tight, better than VIII according to ANSI/FCI 70-3.



EN 14382



PED-CE



Pressure switch

types and ranges

Pressostatic device spring ranges					
SSV Type	Model	Operation	Range Wh		Spring Table web link
			KPa	mbarg	
SN	91	OPSO	2.5 - 110	25 - 1100	TT 1381
		UPSO	1 - 90	10 - 900	
SN (Upside-down)	91	OPSO	2.5 - 110	25 - 1100	TT 1381
		UPSO	1 - 90	10 - 900	
SSV Type	Model	Operation	Range Wh		Spring Table web link
			MPa	barg	
SN	92	OPSO	0.07 - 0.5	0.7 - 5	TT 1381
		UPSO	0.025 - 0.301	0.25 - 3.01	

Table 3 Settings table

General link to the calibration tables: [PRESS HERE](#) or use the QR code:



Accessories

- Limit switches
- Remote tripping

In-line Installation

The following example is provided as a recommendation to get the best performance from the slam shut valves SCN.

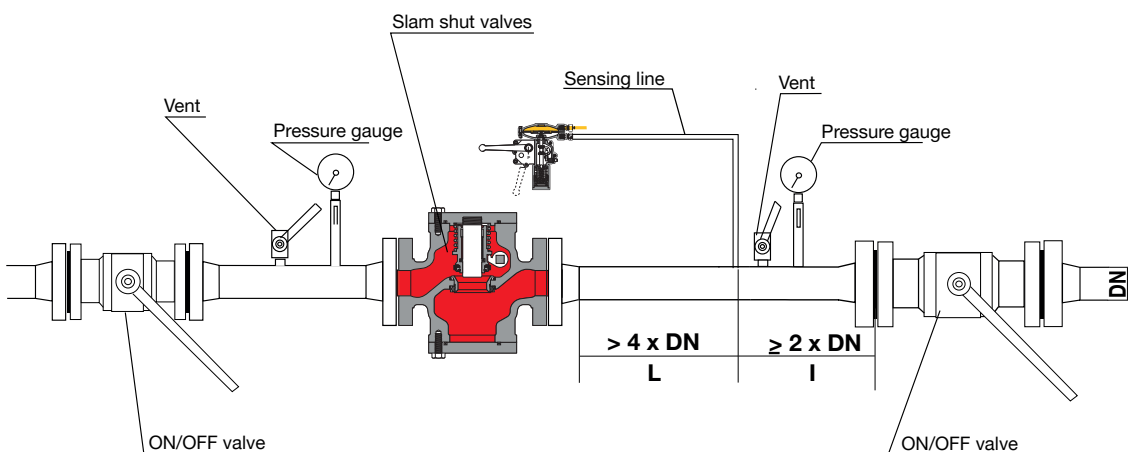

Figure 4 SCN inline installation

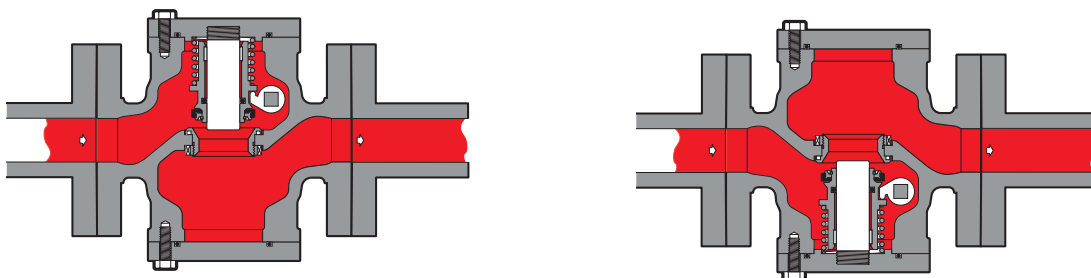

Figure 5 SCN recommended installations





Weights and Dimensions

SCN

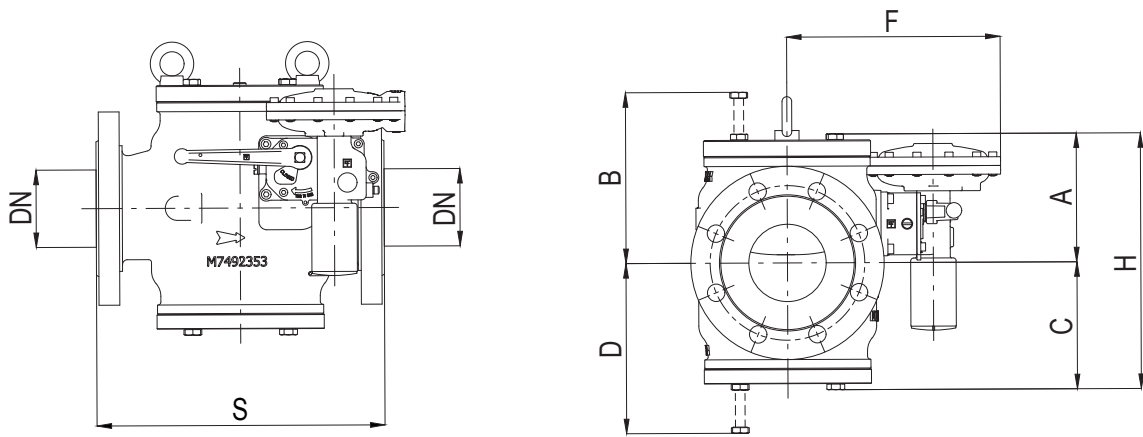

Figure 6 SCN dimensions

Weights and Dimensions (for other connections please contact your closest Pietro Fiorentini representative)																
Size (DN) - [mm]	25		40		50		65		80		100		150		200	
Size (DN) - inches	1"		1" 1/2		2"		2" 1/2		3"		4"		6"		8"	
	[mm]	inches	[mm]	inches	[mm]	inches	[mm]	inches	[mm]	inches	[mm]	inches	[mm]	inches	[mm]	inches
S	183	7.2"	223	8.8"	254	10.0"	277	10.9"	298	11.7"	352	13.9"	451	17.8"	543	21.4"
A	95	3.7"	115	4.5"	115	4.5"	135	5.3"	135	5.3"	180	7.1"	230	9.1"	260	10.2"
B	125	4.9"	145	5.7"	145	5.7"	165	6.5"	165	6.5"	230	9.1"	280	11.0"	310	12.2"
C	95	3.7"	110	4.3"	110	4.3"	135	5.3"	135	5.3"	180	7.1"	225	8.9"	260	10.2"
D	120	4.7"	135	5.3"	135	5.3"	165	6.5"	165	6.5"	230	9.1"	275	10.8"	310	12.2"
F	200	7.9"	200	7.9"	200	7.9"	225	8.9"	225	8.9"	275	10.8"	325	12.8"	360	14.2"
H	190	7.5"	225	8.9"	225	8.9"	270	10.6"	270	10.6"	355	14.0"	450	17.7"	515	20.3"
Tubing Connections	Øe 10 x Øi 8 (on request imperial sizing)															
Weight	Kg	lbs	Kg	lbs	Kg	lbs	Kg	lbs	Kg	lbs	Kg	lbs	Kg	lbs	Kg	lbs
	25	55	33	73	42	93	46	101	51	112	92	203	160	353	270	595

Table 4 Weights and dimensions

Sizing and Cg

In general, the choice of a slam-shut valve is made of several factors, but primarily by the differential pressure drop generated downstream and the energy generated by the gas flow on the internal mechanism. For this purpose Pietro Fiorentini has developed a specific online tool for slam-shut valve sizing following the calculation guidelines available from EN14382 standard.

For sizing [PRESS HERE](#) or use the QR code:



Note: In case you do not have the proper credentials to access, feel free to contact your closest Pietro Fiorentini representative.



Customer Centricity

Pietro Fiorentini is one of the main Italian international companies with high focus on product and service quality.

The main strategy is to create a stable long-term oriented relationship, putting the customer's needs first. Lean management and thinking and customer centricity are used to improve and maintain the highest level of customer experience.



Support

One of Pietro Fiorentini's top priorities is to provide support to the client in all phases of project development, during installation, commissioning and operation. Pietro Fiorentini has developed a highly standardized intervention management system, which helps to facilitate the entire process and effectively archive all the interventions carried out, drawing on valuable information to improve the product and service. Many services are available remotely, avoiding long waiting times or expensive interventions.



Training

Pietro Fiorentini offers training services available for both experienced operators and new users. The training is composed of the theoretical and the practical parts, and is designed, selected and prepared according to the level of use and the customer's need.



Customer Relation Management (CRM)

The centrality of customer is one of the main missions and vision of Pietro Fiorentini. For this reason, Pietro Fiorentini has enhanced the customer relation management system. This enables to track every opportunity and request from Customer in one single point and make free the information flow.



Pietro Fiorentini

TB0046ENG



The data are not binding. We reserve the right
to make changes without prior notice.

scn_technicalbrochure_ENG_revB

www.fiorentini.com