

RSE - RSV

Diaphragm smart meter



Revision D - Edition 11/2024

**USE, MAINTENANCE
AND WARNING
MANUAL**

1 - INTRODUCTION

FOREWORD

All rights reserved. No part of this publication may be reproduced, distributed, translated into other languages or transmitted by any electronic or mechanical media, including photocopies, recording or any other storage and retrieval system, for any other purposes that are not exclusively the personal use of the buyer, without the express written permission of the Manufacturer.

The manufacturer is in no way responsible for the consequences of operations carried out in a manner not in accordance with the manual.

GENERAL REMARKS

All the operating, maintenance instructions and recommendations described in this manual must be adhered to in order to:

- obtain the best possible performance from the equipment;
- keep the equipment in efficient conditions.

Training the personnel in charge is essential in order to:

- use and service the equipment properly;
- correctly apply the safety alerts and procedures recommended.

NOTICE!

The images shown in this document indicate the type of product and may differ in detail.

1.1 - REVISION HISTORY

Revision index	Date
A	12/2022
B	03/2023
C	06/2023
D	11/2024

Tab. 1.1.

INDEX

1 - INTRODUCTION	3
1.1 - REVISION HISTORY.....	5
2 - GENERAL INFORMATION	11
2.1 - MANUFACTURER IDENTIFICATION	11
2.2 - IDENTIFICATION OF THE PRODUCT	11
2.3 - REGULATORY FRAMEWORK.....	12
2.4 - WARRANTY	12
2.4.1 - REFERENCE OPERATING CONDITIONS	13
2.5 - ADDRESSEES, SUPPLY AND STORAGE OF THE MANUAL.....	14
2.6 - LANGUAGE	14
2.7 - SYMBOLS USED IN THE MANUAL.....	15
2.8 - NAMEPLATES APPLIED	16
2.8.1 - IDENTIFIER OF THE LOGIC DEVICE	19
2.8.1.1 - TYPE OF GAUGE	19
2.8.1.2 - REMOTE COMMUNICATION TYPE	19
2.8.2 - DESCRIPTION OF THE NAMEPLATES.....	20
2.9 - GLOSSARY OF MEASUREMENT UNITS.....	21
2.10 - QUALIFIED PROFESSIONAL FIGURES.....	22
3 - SAFETY	23
3.1 - GENERAL SAFETY WARNINGS.....	23
3.2 - ATEX DIRECTIVE SAFETY INSTRUCTIONS	24
3.2.1 - ELECTROSTATIC DISCHARGES.....	24
3.2.2 - CONNECTING TO OTHER DEVICES.....	24
3.2.3 - POWER SUPPLY DEVICES	25
3.2.4 - SAFETY INSTRUCTIONS FOR INSTALLATION IN HAZARDOUS AREA.....	26
3.3 - PERSONAL PROTECTIVE EQUIPMENT.....	27
3.4 - OBLIGATIONS AND PROHIBITIONS	28
3.5 - RESIDUAL RISKS	29
3.5.1 - POTENTIAL DANGER OF ELECTROSTATIC CHARGES.....	29
3.6 - SAFETY AND FRAUD PREVENTION	30
3.6.1 - SEALS	31
3.7 - SAFETY PICTOGRAMS	32
3.8 - RISK LEVEL	32

4 - DESCRIPTION AND OPERATION 33

4.1 - GENERAL DESCRIPTION	33
4.1.1 - POWER SUPPLY DEVICES	34
4.1.1.1 - CONNECTION OF THE POWER SUPPLY DEVICES	34
4.1.1.2 - POWER SUPPLY STATUS	34
4.1.2 - SHUT-OFF VALVE (OPTIONAL).....	35
4.1.3 - ACQUISITION OF THE MEASURE.....	35
4.1.4 - EVENTS AND DIAGNOSTICS.....	36
4.1.5 - ACTIVATION AND CONFIGURATION.....	36
4.1.6 - COMMUNICATION INTERFACES	36
4.1.7 - USER INTERFACE.....	36
4.2 - INTENDED USE	37
4.2.1 - ENVISAGED USE	37
4.2.2 - REASONABLY FORESEEABLE MISUSE	37
4.3 - TECHNICAL DATA	38

5 - USER INTERFACE 39

5.1 - GENERAL DESCRIPTION	39
5.2 - LCD DISPLAY DESCRIPTION	40
5.2.1 - MENU FIELD	41
5.2.2 - UNITS OF MEASUREMENT FIELD	41
5.2.3 - ICONS AND ALARMS FIELD	42
5.3 - START-UP PROCEDURE	43
5.4 - NAVIGATION PROCEDURE	43
5.5 - SEQUENCE OF AVAILABLE MENUS.....	44
5.5.1 - VOLUME TOTALISER AT THE REFERENCE CONDITIONS.....	44
5.5.2 - VOLUME TOTALIZER IN ALARM	44
5.5.3 - VOLUME TOTALISER IN TARIFF RANGE 1	44
5.5.4 - VOLUME TOTALISER IN TARIFF RANGE 2	44
5.5.5 - VOLUME TOTALISER IN TARIFF RANGE 3	45
5.5.6 - VOLUME TOTALISER AT REFERENCE CONDITIONS (END OF PREVIOUS PERIOD).....	45
5.5.7 - VOLUME TOTALISER IN ALARM (END OF PREVIOUS PERIOD)	45
5.5.8 - VOLUME TOTALISER IN TARIFF RANGE 1 (END OF PREVIOUS PERIOD)	45
5.5.9 - VOLUME TOTALISER IN TARIFF RANGE 2 (END OF PREVIOUS PERIOD)	45
5.5.10 - VOLUME TOTALISER IN TARIFF RANGE 3 (END OF PREVIOUS PERIOD)	46
5.5.11 - PERIOD END DATE.....	46
5.5.12 - DIAGNOSTICS	47
5.5.13 - USER MESSAGE	48
5.5.14 - REDELIVERY POINT (PDR) ID	48
5.5.15 - VALVE STATUS	48
5.5.16 - MAXIMUM CONVENTIONAL FLOW RATE (CURRENT PERIOD).....	49
5.5.17 - MAXIMUM CONVENTIONAL FLOW RATE (PREVIOUS PERIOD)	49
5.5.18 - CURRENT FEE SCHEME IDENTIFIER	49
5.5.19 - PREVIOUS FEE SCHEME IDENTIFIER	49
5.5.20 - STATUS OF THE DEVICE	50
5.5.20.1 - SERVICE SUB-MENU.....	50
5.5.21 - DATE.....	51
5.5.21.1 - FIRMWARE SUB-MENU	51
5.5.22 - HOUR	52
5.5.23 - CURRENT RATE	52
5.6 - ALARMS.....	53
5.7 - OPENING THE SHUT-OFF VALVE	53

6 - TRANSPORT AND HANDLING 55

6.1 - SPECIFIC WARNINGS FOR TRANSPORT AND HANDLING	55
6.1.1 - PACKAGING AND FASTENERS USED FOR TRANSPORT	55
6.2 - PACKAGING CONTENT.....	56
6.3 - PHYSICAL CHARACTERISTICS RSE-RSV (1.2 LA).....	57
6.4 - PHYSICAL CHARACTERISTICS RSE-RSV (2.4 LA).....	58
6.5 - EQUIPMENT ANCHORING AND LIFTING METHOD.....	59
6.5.1 - FORKLIFT HANDLING METHOD.....	60
6.6 - PACKAGING REMOVAL.....	62
6.6.1 - PACKAGING DISPOSAL	62
6.7 - STORAGE AND ENVIRONMENTAL CONDITIONS	63
6.7.1 - STORAGE OF THE SPARE BATTERIES	63

7 - INSTALLATION 65

7.1 - GENERAL WARNINGS	65
7.2 - INSTALLATION PRE-REQUISITES.....	65
7.2.1 - ALLOWED ENVIRONMENTAL CONDITIONS.....	65
7.3 - CHECKS BEFORE INSTALLATION.....	66
7.4 - SPECIFIC SAFETY INSTRUCTIONS FOR THE INSTALLATION STEP	67
7.5 - INSTALLATION PROCEDURE	68

8 - CONFIGURATION 71

8.1 - SAFETY REQUIREMENTS FOR CONFIGURATION	71
8.2 - EQUIPMENT CONFIGURATION	71
8.2.1 - USING THE OPTICAL PROBE.....	71
8.3 - VERIFY CORRECT CONFIGURATION.....	71
8.4 - CONNECTING TO OTHER DEVICES	71
8.5 - FIRMWARE UPDATE.....	72

9 - MAINTENANCE AND FUNCTIONAL CHECKS..... 73

9.1 - GENERAL WARNINGS	73
9.2 - SPECIAL MAINTENANCE	74
9.2.1 - REPLACING THE COMMUNICATION BATTERY PACK	74
9.2.2 - SIM REPLACEMENT (GPRS AND NB-IOT VERSIONS ONLY).....	77
9.3 - METROLOGICAL VERIFICATIONS IN THE LABORATORY	79
9.3.1 - REQUIREMENTS FOR SETTING UP THE TEST	79
9.3.2 - TEST PROCEDURE	80

10 - UNINSTALLATION AND DISPOSAL 81

10.1 -GENERAL SAFETY WARNINGS.....	81
10.2 -QUALIFICATION OF THE OPERATORS IN CHARGE.....	81
10.3 -UNINSTALLATION.....	81
10.4 -INFORMATION REQUIRED IN CASE OF NEW INSTALLATION.....	82
10.5 -STORAGE OF THE BATTERIES	82
10.6 -INFORMATION REQUIRED IN CASE OF RE-INSTALLATION.....	82
10.7 -DISPOSAL INFORMATION.....	82
10.7.1 -DISPOSING OF THE BATTERIES	83
10.7.1.1 - BATTERY REMOVAL	84
10.7.1.2 - BATTERY PACKAGING.....	85

11 - RECOMMENDED SPARE PARTS 87

11.1 -GENERAL WARNINGS	87
11.2 -HOW TO REQUEST SPARE PARTS.....	87
11.3 -SPARE PARTS LIST	88
11.4 -PUTTING BACK BATTERIES.....	89

2 - GENERAL INFORMATION

2.1 - MANUFACTURER IDENTIFICATION

Manufacturer	PIETRO FIORENTINI S.P.A.
Address	Via Enrico Fermi, 8/10 36057 Arcugnano (VI) - ITALY Tel. +39 0444 968511 Fax +39 0444 960468 www.fiorentini.com sales@fiorentini.com

Tab. 2.2.

NOTICE!

For any problem encountered on the installed equipment, contact the distributor of the reference gas mains.

2.2 - IDENTIFICATION OF THE PRODUCT

Equipment	DIAPHRAGM SMART METER
Series	RSE - RSV
Available models	<ul style="list-style-type: none"> • RSE 1,2 LA N1 • RSE / 1,2 LA RF169 • RSE / 1,2 LA GPRS • RSE 2,4 LA N1 • RSE / 2,4 LA RF169 • RSE / 2,4 LA GPRS • RSV / 1,2 LA N1 • RSV / 2,4 LA N1

Tab. 2.3.

2.3 - REGULATORY FRAMEWORK

PIETRO FIORENTINI S.P.A. with registered office in Arcugnano (Italy) - Via E. Fermi, 8/10, declares that the equipment of the RSE - RSV series described in this manual is designed, manufactured, tested and checked in compliance with:

- the requirements of the Directives:
 - 2014/32/EU "MID";
 - 2014/34/EU "ATEX";
 - 2014/53/EU "RED";
 - 2011/65/UE "RoHS 2";
 - 2015/863 "RoHS";
 - 2012/19/EU "WEEE";
- resolution 631/2013/R/gas of the Regulatory Authority for Energy, Networks and Environment (ARERA) and ratified in the UNI/TS 11291 package of standards;
- EN 1359:2017 (product standard for 'Diaphragm gas meters').

For the harmonised product standards of each directive, please refer to the EU Declaration of Conformity accompanying the metering instrument..

NOTICE!

For specific type approvals, see the appropriate section on the Manufacturer's website: <https://www.fior-entini.com>

NOTICE!

The declaration of conformity in its original version is delivered together with the equipment.

2.4 - WARRANTY

PIETRO FIORENTINI S.P.A. guarantees that the equipment was manufactured using the best materials, with high quality workmanship, and complies with the quality requirements, specifications and performance set out in the order.

The warranty shall be considered null and void and PIETRO FIORENTINI S.P.A. shall not be liable for any damage and/or malfunctions:

- due to any acts or omissions of the purchaser or end-user, or any of their carriers, employees, agents, or any third party or entity;
- in the event that the purchaser, or a third party, makes changes to the equipment supplied by PIETRO FIORENTINI S.P.A. without the prior written approval of the latter;
- in the event of failure by the purchaser to comply with the instructions contained in this manual, as provided by PIETRO FIORENTINI S.P.A.

NOTICE!

The warranty conditions are specified in the commercial contract.

2.4.1 - REFERENCE OPERATING CONDITIONS

The reference operating conditions to calculate the life span of the batteries are described in the UNI/TS 11291-11-1 and 11291-12-1 standards. An extract of these standards is found in Tab. 2.4:

Operative condition	Reference indications
User interface	Display: 10 minutes per month.
	Optical interface: 5 minutes per month.
Shut-off valve	Valve movement cycles (cycle = closing and re-opening): 2 cycles per year.
Temperature measurement of gas	Frequency of measurement: 30 seconds.
Range	Qmax
Firmware update	Number of firmware updates: <ul style="list-style-type: none"> RF 169 model: 2 (over the service life of the equipment); GPRS and NB-IoT model: 3 (over the service life of the equipment).
Communication	Frequency and duration of communications: <ul style="list-style-type: none"> Model RF169: up to 3 spontaneous transmissions per day, including one tx/rx, RF channel @2400 bps. GPRS model: 1 communication session per day, with registration duration of 20 sec. and data tx/rx phase of 30 sec. NB-IoT model: 1 transmission per day with a maximum session duration of 60 sec., in PSM (Power Saving Mode) with one registration to the network per year.

Tab. 2.4.

Ambient temperature has an effect on battery life. The operating profile used to calculate the battery life expectancy is indicated in Tab. 2.5:

	Reference indications
Temperature environment	5% of the time at -25 °C
	20% of the time at -10 °C
	50% of the time at +22 °C
	20% of the time at +55 °C
	5% of the time at +70 °C

Tab. 2.5.

2.5 - ADDRESSEES, SUPPLY AND STORAGE OF THE MANUAL

The instruction manual is intended for qualified technicians responsible for operating and managing the equipment throughout its service life.

It contains the necessary information to properly use the equipment and keep its functional and qualitative characteristics unchanged over time. All information and warnings for safe, correct use are also provided.

The manual, as well as the declaration of conformity and/or test certificate, is an integral part of the equipment and must always accompany it whenever it is moved or resold. It is the responsibility of the qualified professionals (see paragraph 2.10) to use and manage the equipment.

WARNING!

Removing, rewriting or modifying the pages of the manual and their contents is not allowed.

PIETRO FIORENTINI S.p.A. shall not be held liable for any damage to people, animals and property caused by failure to adhere to the warnings and operating procedures described in this manual.

2.6 - LANGUAGE

The original instruction manual was drawn up in Italian.

Any translations into additional languages are to be made from the original instruction manual.

HAZARD!

The translations into other languages cannot be fully verified. If any inconsistency is found, please refer to the original instruction manual.



If inconsistencies are found or the text does not make sense:

- **stop any actions;**
- **immediately contact PIETRO FIORENTINI S.p.A. at the addresses specified in paragraph 2.1 (“Identification of the manufacturer”).**

WARNING!

PIETRO FIORENTINI S.p.A. shall be held liable for the information provided in the original manual only.

2.7 - SYMBOLS USED IN THE MANUAL

Symbol	Definition
	Symbol used to identify important warnings for the safety of the operator and/or equipment.
	Symbol used to identify information of particular importance in the instruction manual. The information may also concern the safety of the personnel involved in using the equipment.
	Obligation to consult the instruction manual/booklet. Indicates a requirement for the personnel to refer to (and understand) the operating and warning instructions of the machine before working with or on it.

Tab. 2.6.

HAZARD!

Alerts to a hazard with a high level of risk, an imminent hazardous situation which, if not prevented, will result in death or severe damage.

WARNING!

Alerts to a hazard with a medium level of risk, a potentially hazardous situation which, if not prevented, may result in death or severe damage.

ATTENTION!

Alerts to a hazard with a low level of risk, a potentially hazardous situation which, if not prevented, could result in minor or moderate damage.

NOTICE!

Alerts to specific warnings, directions or notes of particular concern, that are not related to physical injury, as well as practices for which physical injury is not likely to occur.

2.8 - NAMEPLATES APPLIED

WARNING!

Removing nameplates and/or replacing them with other plates is strictly not allowed. Should the plates be unintentionally damaged or removed, the customer must notify PIETRO FIORENTINI S.p.A.

NOTICE!

Variants of the metrological covers can be provided on demand for:

- compliance with local regulations;
- other specific requests.



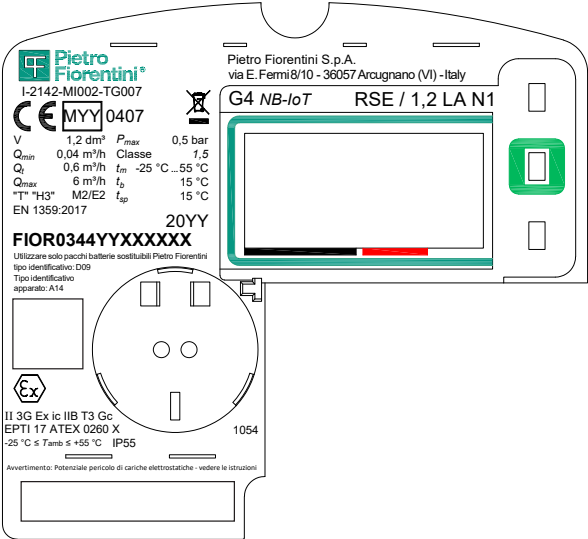
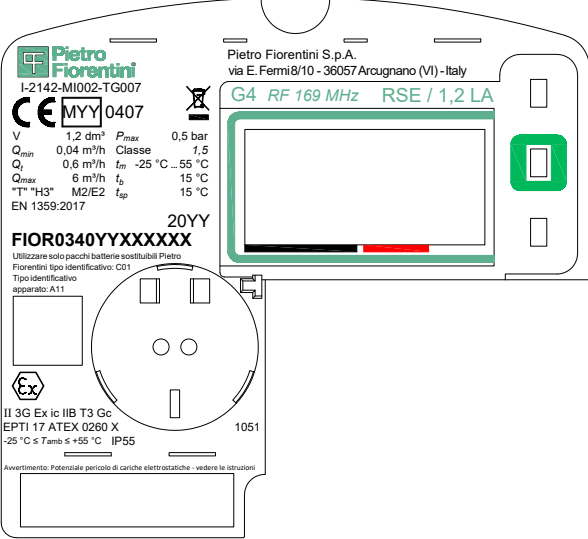

The equipment and its accessories are provided with nameplates (from Id.1 to Id.7).

The nameplates specify identification details of the equipment and its accessories to be provided, if necessary, to PIETRO FIORENTINI S.p.A.

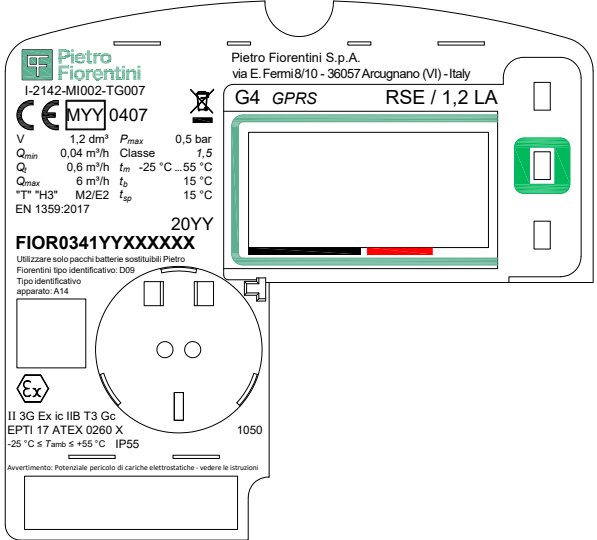
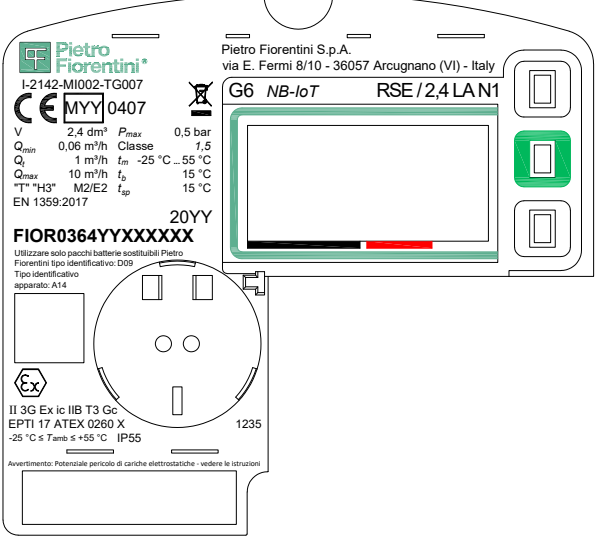
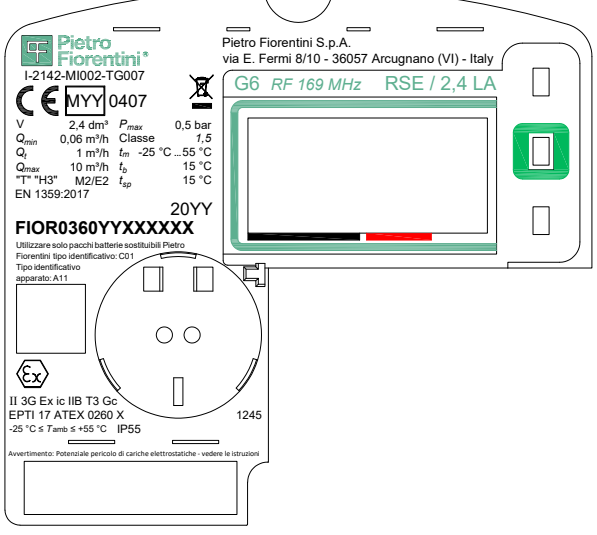
List of identification plates applied to metrological covers:

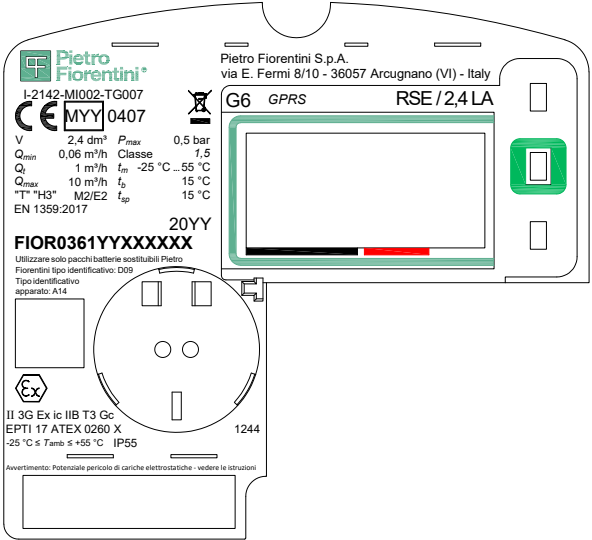
Id.	Reference model	Identification plate drawing
1	RSE / 1.2 LA G4 N1	 <p>The drawing shows a nameplate for the RSE / 1.2 LA G4 N1 model. It includes the Pietro Fiorentini logo, model number I-2142-MI002-TG007, and CE marking with MYY0407. Technical specifications listed include: V=1.2 dm³, P_{max}=0.5 bar, Q_{min}=0.04 m³/h, Classe=1.5, Q_i=0.6 m³/h, t_m=-25 °C...55 °C, Q_{max}=6 m³/h, t_b=15 °C, T^h"H3", M2/E2, t_{sp}=15 °C, and EN 1359:2017. The identification code is FIOR0344YYXXXXXX. It also features an Ex marking for II 3G Ex ic IIB T3 Gc, EPTI 17 ATEX 0260 X, -25 °C ≤ T_{amb} ≤ +55 °C, IP55, and a warning about electrostatic discharge.</p>
2	RSE / 1.2 LA G4 RF169	 <p>The drawing shows a nameplate for the RSE / 1.2 LA G4 RF169 model. It includes the Pietro Fiorentini logo, model number I-2142-MI002-TG007, and CE marking with MYY0407. Technical specifications listed include: V=1.2 dm³, P_{max}=0.5 bar, Q_{min}=0.04 m³/h, Classe=1.5, Q_i=0.6 m³/h, t_m=-25 °C...55 °C, Q_{max}=6 m³/h, t_b=15 °C, T^h"H3", M2/E2, t_{sp}=15 °C, and EN 1359:2017. The identification code is FIOR0340YYXXXXXX. It also features an Ex marking for II 3G Ex ic IIB T3 Gc, EPTI 17 ATEX 0260 X, -25 °C ≤ T_{amb} ≤ +55 °C, IP55, and a warning about electrostatic discharge.</p>

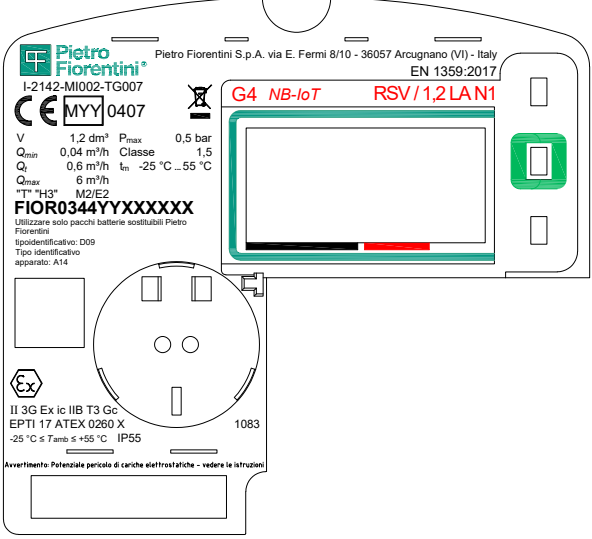
Id.	Reference model	Identification plate drawing
3	RSE / 1.2 LA G4 GPRS	 <p>Pietro Fiorentini I-2142-MI002-TG007 CE MYY 0407 V 1,2 dm³ P_{max} 0,5 bar Q_{min} 0,04 m³/h Classe 1,5 Q_i 0,6 m³/h t_m -25 °C...55 °C Q_{max} 6 m³/h t_b 15 °C T⁺ "H3" M2/E2 t_{sp} 15 °C EN 1359:2017 20YY FIOR0341YYXXXXXX Utilizzare solo pacchi batterie sostituibili Pietro Fiorentini tipo identificativo: D09 Tipo identificativo apparato: A14 II 3G Ex ic IIB T3 Gc EPTI 17 ATEX 0260 X -25 °C ≤ T_{amb} ≤ +55 °C IP55 Avvertimento: Potenziale pericolo di cariche elettrostatiche - vedere le istruzioni</p>
4	RSE / 2.4 LA G6 N1	 <p>Pietro Fiorentini I-2142-MI002-TG007 CE MYY 0407 V 2,4 dm³ P_{max} 0,5 bar Q_{min} 0,06 m³/h Classe 1,5 Q_i 1 m³/h t_m -25 °C...55 °C Q_{max} 10 m³/h t_b 15 °C T⁺ "H3" M2/E2 t_{sp} 15 °C EN 1359:2017 20YY FIOR0364YYXXXXXX Utilizzare solo pacchi batterie sostituibili Pietro Fiorentini tipo identificativo: D09 Tipo identificativo apparato: A14 II 3G Ex ic IIB T3 Gc EPTI 17 ATEX 0260 X -25 °C ≤ T_{amb} ≤ +55 °C IP55 Avvertimento: Potenziale pericolo di cariche elettrostatiche - vedere le istruzioni</p>
5	RSE / 2.4 LA G6 RF169	 <p>Pietro Fiorentini I-2142-MI002-TG007 CE MYY 0407 V 2,4 dm³ P_{max} 0,5 bar Q_{min} 0,06 m³/h Classe 1,5 Q_i 1 m³/h t_m -25 °C...55 °C Q_{max} 10 m³/h t_b 15 °C T⁺ "H3" M2/E2 t_{sp} 15 °C EN 1359:2017 20YY FIOR0360YYXXXXXX Utilizzare solo pacchi batterie sostituibili Pietro Fiorentini tipo identificativo: C01 Tipo identificativo apparato: A11 II 3G Ex ic IIB T3 Gc EPTI 17 ATEX 0260 X -25 °C ≤ T_{amb} ≤ +55 °C IP55 Avvertimento: Potenziale pericolo di cariche elettrostatiche - vedere le istruzioni</p>

Id.	Reference model	Identification plate drawing
6	RSE / 2.4 LA G6 GPRS	 <p> Pietro Fiorentini Pietro Fiorentini S.p.A. via E. Fermi 8/10 - 36057 Arcugnano (VI) - Italy EN 1359:2017 </p> <p> L-2142-MI002-TG007 CE MYY 0407 </p> <p> G6 GPRS RSE / 2,4 LA </p> <p> V 2,4 dm³ P_{max} 0,5 bar Q_{min} 0,06 m³/h Classe 1,5 Q 1 m³/h t_m -25 °C...55 °C Q_{max} 10 m³/h t_b 15 °C "T" "H3" M2/E2 t_{sp} 15 °C EN 1359:2017 </p> <p> 20YY FIOR0361YYXXXXXX Utilizzare solo pacchi batterie sostituibili Pietro Fiorentini Tipo identificativo: D09 Tipo identificativo apparato: A14 </p> <p>  II 3G Ex ic IIB T3 Gc EPTI 17 ATEX 0260 X -25 °C ≤ T_{amb} ≤ +55 °C IP55 </p> <p> 1244 Avvertimento: Potenziale pericolo di cariche elettrostatiche - vedere le istruzioni </p>
7	RSV / 1.2 LA G4 N1	 <p> Pietro Fiorentini Pietro Fiorentini S.p.A. via E. Fermi 8/10 - 36057 Arcugnano (VI) - Italy EN 1359:2017 </p> <p> L-2142-MI002-TG007 CE MYY 0407 </p> <p> G4 NB-IoT RSV / 1,2 LA N1 </p> <p> V 1,2 dm³ P_{max} 0,5 bar Q_{min} 0,04 m³/h Classe 1,5 Q 0,6 m³/h t_m -25 °C...55 °C Q_{max} 6 m³/h "T" "H3" M2/E2 EN 1359:2017 </p> <p> 20YY FIOR0344YYXXXXXX Utilizzare solo pacchi batterie sostituibili Pietro Fiorentini Tipo identificativo: D09 Tipo identificativo apparato: A14 </p> <p>  II 3G Ex ic IIB T3 Gc EPTI 17 ATEX 0260 X -25 °C ≤ T_{amb} ≤ +55 °C IP55 </p> <p> 1083 Avvertimento: Potenziale pericolo di cariche elettrostatiche - vedere le istruzioni </p>

Tab. 2.7.

2.8.1 - IDENTIFIER OF THE LOGIC DEVICE

Term	Description
Format	FIO-R-03-WV-YY-XXXXXX.
FIO	Fixed field indicating the manufacturer (PIETRO FIORENTINI S.p.A.) according to the encoding of the Flag Association.
R	Type of meter: RSE/RSV.
03	Type of device (03=Gas Meter).
W	Type of gauge.
V	Remote communication type.
YY	Year of manufacture.
XXXXXX	Progressive number.

Tab. 2.8.

2.8.1.1 - TYPE OF GAUGE

Code "W" version	Gauge value
"1"	G1,6
"2"	G2,5
"4"	G4
"6"	G6

Tab. 2.9.

2.8.1.2 - REMOTE COMMUNICATION TYPE

Code "V" version	Type of communication	Model suffix
"0"	RF 169 MHz	RF169
"1"	GPRS	GPRS
"2"	RF 868 MHz	RF868
"4"	NB-IoT (B20 default)	N1

Tab. 2.10.

2.8.2 - DESCRIPTION OF THE NAMEPLATES

The following information, described in Tab. 2.11, is shown on the nameplate:

Pos.	Description
1	Manufacturer's Logo.
2	Manufacturer's Address.
3	Logical device identifier (see section 2.8.1).
4	Model type.
5	"MID" Directive marking.
6	Reference standard for 'domestic diaphragm gas meters', Manufacturer's calibrations, approval levels and meter reference class.
7	"ATEX" Directive marking.
8	Gauge value.
9	Type of communication.
10	Disposal guidelines (WEEE Directive 2012/19/EU).
11	References for battery replacement.
12	Degree of protection from external agents.

Tab. 2.11.

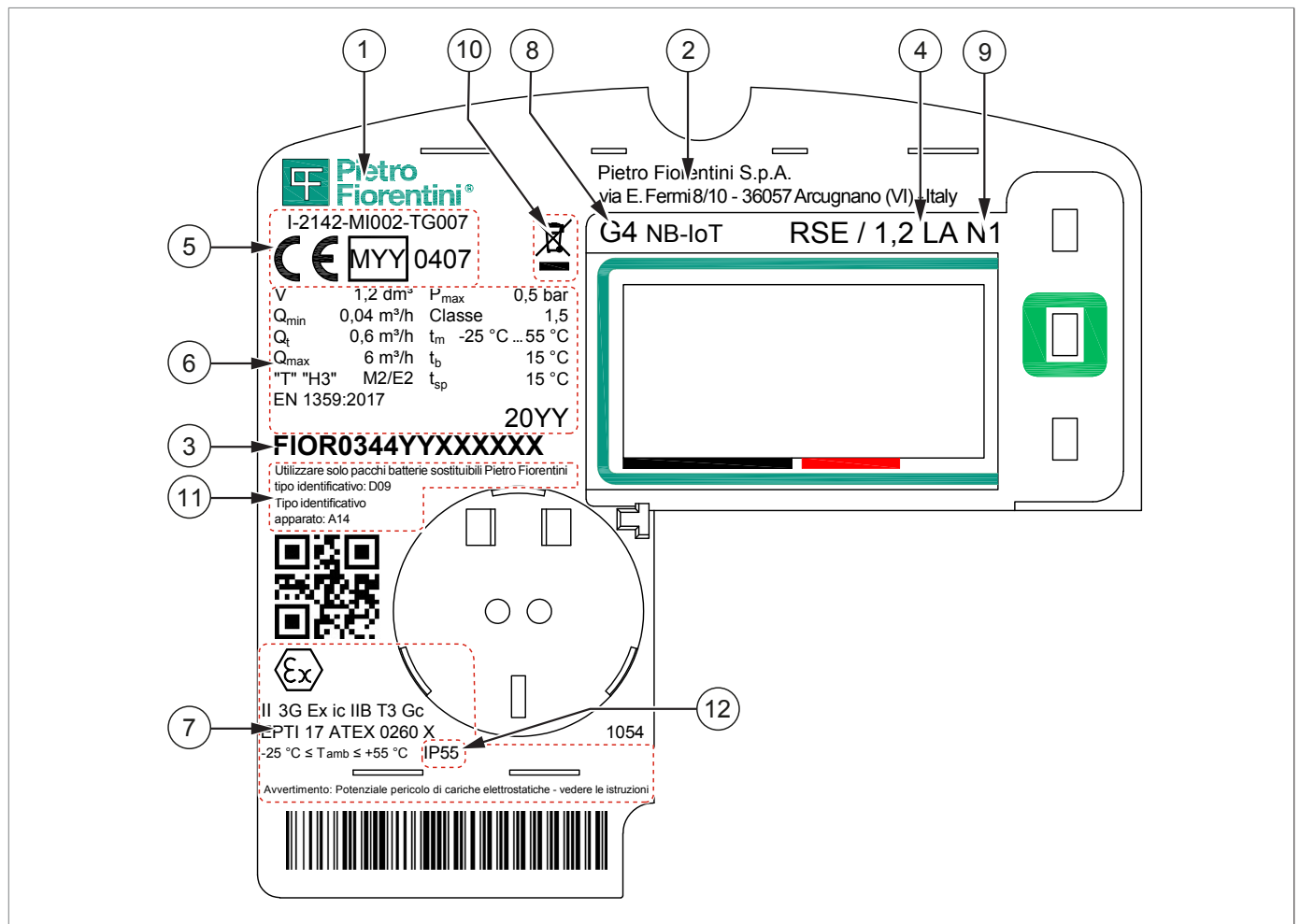

Fig. 2.1. Description of the nameplates

2.9 - GLOSSARY OF MEASUREMENT UNITS

Type of measurement	Unit of measurement	Description
Consumption and Volumetric flow rate	Sm ³ /h	Standard cubic metres per hour
	Sm ³	Standard cubic metres
	m ³ /h	Cubic metres per hour
	m ³	Cubic metres
Pressure	bar	Bar
	ˆwc	Water column inch
	Pa	Pascal
Temperature	°C	Degree centigrade
	K	Kelvin
Tightening torque	Nm	Newton metro
Other measures	V	Volt
	W	Watt
	Ω	Ohm

Tab. 2.12.

2.10 - QUALIFIED PROFESSIONAL FIGURES

Qualified operators in charge of using and managing the equipment throughout its technical service life to be used as indicated:

Professional figure	Definition
Installer	<p>Qualified operator able to:</p> <ul style="list-style-type: none"> • handle materials and equipment. • carry out all the operations necessary to properly install the equipment; • perform all the operations necessary to safely operate the equipment and system; • be able to perform all the operations necessary to uninstall and subsequently dispose of the equipment in compliance with the regulations in force in the country of installation.
Specialised technician/ Maintenance technician	<p>Trained and authorised technician on the management and use of the equipment, who must:</p> <ul style="list-style-type: none"> • be able to perform all operations required for the proper functioning of the equipment and the system, and for their safety and that of any third parties present; • perform maintenance on all parts of the equipment subject to maintenance (board and batteries); • access all device parts for visual inspection, checking equipment status, making adjustments and calibrations; • have proven experience in properly using the equipment similar to that described in this manual, and be trained, informed and instructed in this regard.

Tab. 2.13.

3 - SAFETY

3.1 - GENERAL SAFETY WARNINGS

WARNING!

The equipment described in this manual is normally installed in systems which transport flammable gases (for example natural gas).

WARNING!

If the gas used is a combustible gas, the installation area of the equipment is defined as a “danger zone” as there are residual risks that potentially explosive atmospheres may be generated.

In “danger zones” and in close proximity thereto:

- there must not be any effective sources of ignition;
- no smoking.

WARNING!

- It is strictly forbidden to repair or make any modifications to the equipment.
- For information and warnings regarding replacing batteries, refer to chapter 9 in this manual.

ATTENTION!

Authorised operators must not carry out operations or services on their own initiative that do not fall within their competence.

Never operate the equipment:

- while under the influence of intoxicating substances such as alcohol;
- if you are using drugs that may slow reaction times.

NOTICE!

The employer must train and inform operators on how to behave during operations and on the equipment to be used.

Before installation, commissioning or maintenance, operators must:

- take note of the safety regulations applicable to the place of installation they are working in;
- obtain the necessary permits to operate when required;
- wear the personal protective equipment required by the procedures described in this instruction manual;
- ensure that the area that they are operating in is equipped with the required collective protections and the necessary safety information.

3.2 - ATEX DIRECTIVE SAFETY INSTRUCTIONS

The RSE - RSV meter is an intrinsically safe apparatus suitable for use in hazardous areas classified as Zone 2.
ATEX marking:

 II 3G Ex ic IIB T3 Gc ($-25\text{ °C} \leq T_{\text{amb}} \leq +55\text{ °C}$).

Term	Description
	Specific symbol for equipment suitable for use in potentially explosive atmospheres due to the presence of gas
II	Use in surface installations with explosive atmospheres due to the presence of gas.
3G	Category of equipment suitable for installation in Zone 2 classified atmospheres.
Ex	Electrical equipment designed and constructed for use in potentially explosive environments.
ic	Electrical equipment designed and constructed for use in potentially explosive environments.
IIB	Suitability for use in areas where category IIB gases are present.
T3	Maximum allowable surface temperature 200°C.
Gc	Electrical equipment designed and constructed for use in potentially explosive environments.

Tab. 3.14.

The harmonised CENELEC standards relevant for compliance with EHSR requirements (Essential Health and Safety Requirement) of the ATEX directive are the standards: EN IEC 60079-0:2018 and EN 60079-11:2012.

3.2.1 - ELECTROSTATIC DISCHARGES

This device is approved for installation in areas with low explosion risk (risk is only present for short periods). In these areas, sparks produced by electrostatic discharges might still generate explosions in extreme cases.

WARNING!

During installation or use of this device, it is appropriate to take steps to assure protection against electrostatic discharges.

Further information can be found in EN60079-32-1: among the possible actions, an example is using dissipative footwear and a damp cloth (>65%) during installation/maintenance operations.

NOTICE!

PIETRO FIORENTINI S.p.A. disclaims any liability resulting from the risks and consequences caused by non-compliance with these provisions.

3.2.2 - CONNECTING TO OTHER DEVICES

The RSE - RSV meters can be connected:

- locally to terminal devices via the optical port;
- remotely to the Central Acquisition System (CAS) via the integrated radio interface (Wireless MBUS or GPRS or NB-IoT);

for the communication of consumption data and the management of controls useful for the configuration and maintenance of the device.

3.2.3 - POWER SUPPLY DEVICES

RSE - RSV can only be powered by the specific battery packs approved with the device; using other power sources is prohibited.

ATTENTION!

The battery pack is a device certified for exclusive use with the RSE - RSV meter and it is the only permissible power supply device. Only use original battery packs. In the event of a temporary disconnection of the main power supply, the meter returns the last saved data to the non-volatile memory.

The device uses two distinct battery packs:

- one that is useful for managing the metrological part and local interfaces called the metrological battery pack, which cannot be replaced in the field;
- one that is useful for managing the remote communication part called communication battery pack, which can be replaced in the field.

Each pack consists of a lithium battery with cables ending with a specific connector, enclosed in a protective sheath.

The following relevant data are shown on the battery pack:

- communication battery pack identification code;
- identification type of the device;
- month and year of production (see following warning).

WARNING!

The information on the month and year of production is part of the QR code on the battery. In the QR code there is an alphanumeric code where the last 4 digits represent the month and year of production, as shown in the example below::



V001000001P1121

(QR code with production date November 2021)

3.2.4 - SAFETY INSTRUCTIONS FOR INSTALLATION IN HAZARDOUS AREA

This device must be installed and operated in compliance with the provisions and regulations in force.

NOTICE!

PIETRO FIORENTINI S.p.A. shall not be liable for damage resulting from failure to comply with the instructions and from misuse.

Safety warnings

All operations on the device must be performed by qualified personnel.

Transformation and spare parts

Any technical changes are forbidden. Use only original spare parts intended by PIETRO FIORENTINI S.p.A.

Transport

As a rule, RSE - RSV must be transported in an upright position and inside the original packaging box provided by PIETRO FIORENTINI S.p.A.

Upon receipt of the device, examine the supplied material.

Immediately report any shipping damage.

Storage

As a rule, RSE - RSV must be stored in an upright position and in a dry place at room temperature (refer to paragraph 6.7 "Storage and environmental conditions").

WARNING!







- **The arrow on the top of the device indicates the direction of the gas flow.**
- **Install the device in a compartment that meets the provisions in force on safety, away from any possible damage of mechanical origin, away from sources of heat or naked flames, in a dry place and protected from external agents.**
- **Install the device with the indicator device in a horizontal position, not in contact with walls and raised from the floor.**
- **During installation, avoid mechanical stress to the inlet and outlet connections.**
- **The optional shut-off valve, located in the system upstream of the device, must be opened in a gradual manner in order to allow the gas to flow evenly, without violent shocks that would damage the internal components.**
- **It is strictly forbidden to repair or make any modifications to the device.**
- **The installation, removal, and any operations must be performed by qualified personnel, in compliance with the provisions in force concerning safety.**

3.3 - PERSONAL PROTECTIVE EQUIPMENT

The following table shows the Personal Protective Equipment (PPE) and its description; an obligation is associated with each symbol.

Personal protective equipment means any equipment intended to be worn by the worker in order to protect them against one or several risks that are likely to threaten their safety or health during work.

For the operators in charge, depending on the type of work requested, the most appropriate PPE from those reported in Tab. 3.15 must be used:

Symbol	Meaning
	Obligation to use safety or insulated gloves. Indicates a requirement for the personnel to use safety or insulated gloves.
	Obligation to use safety goggles. Indicates a requirement for personnel to use protective goggles for eye protection.
	Obligation to use safety shoes. Indicates a requirement for the personnel to use accident-prevention safety shoes.
	Obligation to use noise protection equipment. Indicates a requirement for the personnel to use ear muffs or ear plugs to protect their hearing.
	Obligation to wear protective clothing. Indicates a requirement for the personnel to wear specific protective clothing.
	Obligation to use a protective mask. Indicates a requirement for the personnel to use respiratory masks in the event of a chemical risk.
	Obligation to use a protective helmet. Indicates a requirement for the personnel to use protective helmets.
	Obligation to wear high visibility vests. Indicates a requirement for the personnel to use high visibility vests.

Tab. 3.15.

 **WARNING!**

Each licensed operator is obliged to:

- take care of his/her own health and safety and that of other people in the workplace who are affected by his/her actions or omissions, in accordance with the training, instructions and equipment provided by the employer;
- appropriately use the PPE made available;
- immediately report to the employer, the manager or the person in charge of the deficiencies of the means and devices as well as any possible dangerous conditions of which they become aware.

3.4 - OBLIGATIONS AND PROHIBITIONS

The following is a list of obligations and prohibitions to be observed for the safety of the operator:

It is mandatory to:

- carefully read and understand the use, maintenance and warning manual;
- before installing the equipment, strictly refer to the details specified on the nameplates and in the manual;
- avoid knocks and violent impacts that could damage the equipment.

It is forbidden to:

- operate in various capacities on the equipment without the PPE indicated in the work procedures described in this manual;
- operate in the presence of open flames or bring open flames close to the work area;
- smoke near the equipment or while working on it;
- use the equipment with parameters other than those indicated on the nameplate;
- use the equipment with gas units other than those indicated on the meter nameplate;
- use the equipment outside the operating temperature range declared on the identification plate and indicated in this manual;
- install or use the equipment in environments other than those specified in this manual.

3.5 - RESIDUAL RISKS

The equipment does not present residual risks for the operator related to its normal operation.

NOTICE!

The equipment is ATEX Zone 2 Category 3G certified.

During normal activities, it is unlikely for an explosive atmosphere to form in this zone, consisting of a mixture of air and flammable substances in the form of gas, steam or mist and if it occurs, it only lasts a short time (from 0.1h to 10h/365 days).

WARNING!

If there are any functional faults, do not operate.

Immediately contact PIETRO FIORENTINI S.p.A. for the necessary directions.

3.5.1 - POTENTIAL DANGER OF ELECTROSTATIC CHARGES

This device is approved for installation in areas with low explosion risk (risk is only present for short periods).

Due to the gas in the atmosphere, sparks produced in these areas by electrostatic discharges might still generate explosions in extreme cases.

WARNING!

It is mandatory to implement protective measures against electrostatic discharges during installation, configuration and maintenance of the equipment.

The authorised operator must proceed as follows, during the various operational phases, to avoid the risk:

Operational phases	Obligations of the operator
Installation	<ul style="list-style-type: none"> Wear professional safety footwear with ESD characteristics; Wear work clothes that dissipate electrostatic charges; Use a damp cloth for cleaning.
Configuration	<ul style="list-style-type: none"> Wear professional safety footwear with ESD characteristics; Wear work clothes that dissipate electrostatic charges.
Maintenance	<ul style="list-style-type: none"> Wear professional safety footwear with ESD characteristics; Wear work clothes that dissipate electrostatic charges; Use a damp cloth for cleaning.

Tab. 3.16.

3.6 - SAFETY AND FRAUD PREVENTION

The solutions implemented on the equipment to assure safety comply with the requirements set forth by the reference standard in force (UNI/TS 11291). In detail, access is not possible:

- to the electronics without the removal of the mechanical metrological seals and thus without permanent damage to the metrological cover in accordance with the Type Examination Certificate (MID) legalisation plan of the meter;

NOTICE!

When the plastic casing (A) is removed, a mechanical anti-tamper device will trigger a signal that the front panel has been removed.

- to the memory device without permanently and patently damaging the equipment;
- to the flow shut-off valve (optional) and the temperature sensor without permanently and patently damaging the equipment;
- to the metrological battery pack (not replaceable) without removing the mechanical and metrological seal and without permanently damaging the metrological cover;
- to the communication battery pack (replaceable) (C) without compromising the screw cover seals (D) and without leaving a trace of the event in the relevant memory register (Metrological Events Log) of the equipment.

The attempts:

- to tamper with proper operation of the meter are detected and recorded in the Metrological Events Log;
- access to the meter through communication channels:
 - by unauthorised personnel are intercepted and recorded in the Metrological Event Log;
 - with incorrect passwords or encryption keys are intercepted, enumerated and made available to the control centre.

NOTICE!

- **The interface equipment usually available to the user can only be used to read the data and it is not possible to perform any configuration.**
- **The configurations that can be performed through the communication channels which the device is equipped with – which can only be carried out by authorised personnel – leave a track since they are stored in the appropriate memory log (Metrological Events Log).**

Furthermore:

- commands sent from external devices through the communication channels are verified for authenticity of the source;
- the messages transmitted through the communication channels conveying sensitive information are all encrypted;
- the duration of the conditions is monitored and recorded by the firmware.

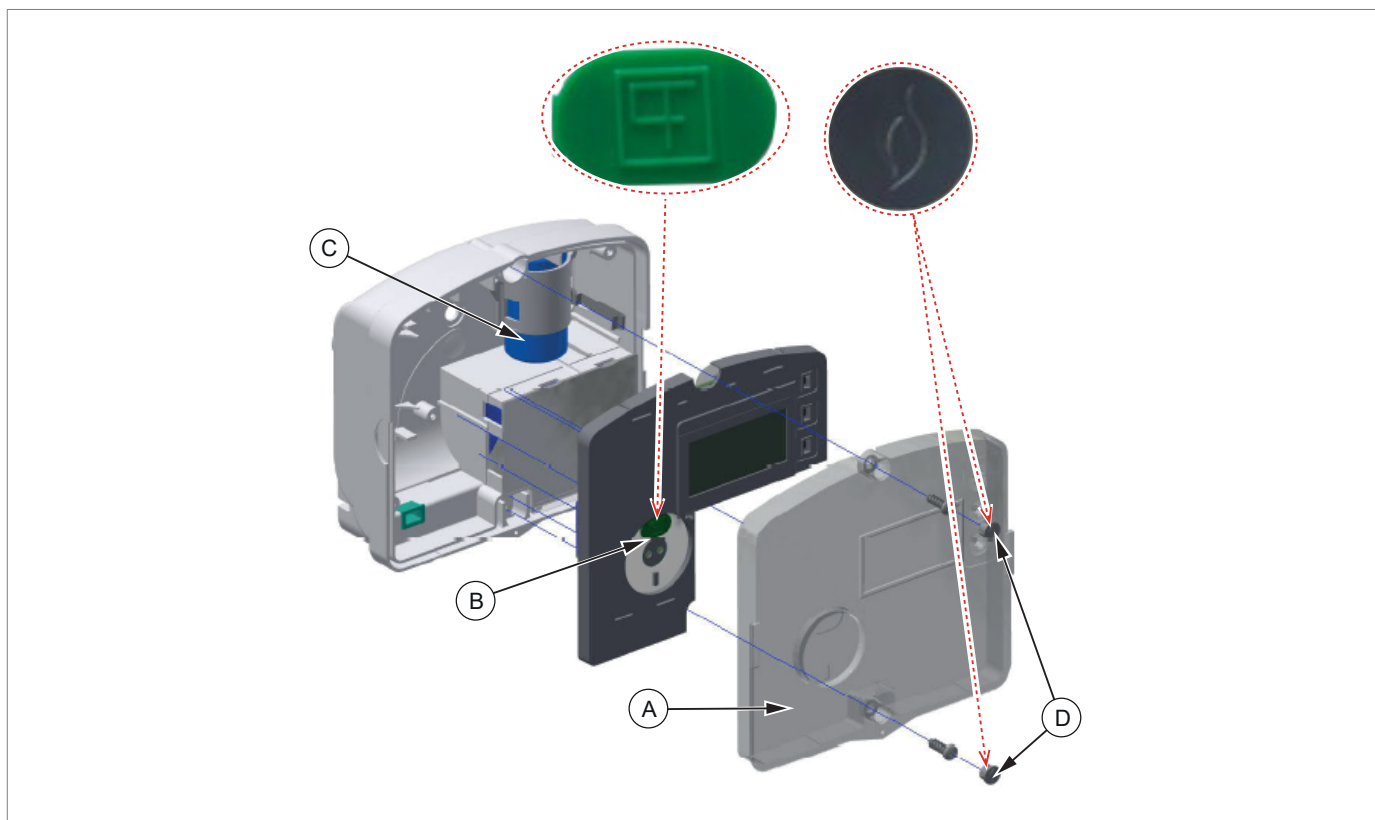



Fig. 3.2. Anti-fraud security RSE - RSV

3.6.1 - SEALS

The PIETRO FIORENTINI S.p.A. equipment has the following seals described in Tab. 3.17:





Symbol	Type	Description
	Screw cover seal	They point out that access to the equipment is not possible without the removal of the seals and the resulting permanent and evident damage to the equipment.
	Metrological seal	

Tab. 3.17.

⚠ WARNING!
It is absolutely forbidden to remove or alter the seals on the equipment.

3.7 - SAFETY PICTOGRAMS

The safety pictograms described in Tab. 3.18 may be shown on the equipment and/or packaging PIETRO FIORENTINI S.p.A.:

Symbol	Definition
	Symbol used to identify a GENERIC HAZARD.
	Symbol used to identify DANGERS GENERATED BY STATIC ELECTRICITY.
	Symbol applied to the packaging to identify the type of danger and risks related to the transported product, based on the classification of the European ADR agreement. Class 9 (Various dangerous substances). ADR - UN3090 (lithium metal batteries).
	The symbol indicates that the product must not be disposed of as unsorted waste but must be sent to separate collection facilities for recovery and recycling (WEEE Directive 2012/19/EU on waste electrical and electronic equipment). A bar below the basket means that the product was placed on the market after 13 August 2005.

Tab. 3.18.

WARNING!

It is absolutely forbidden to remove or alter the safety pictograms on the equipment or the packaging.

3.8 - RISK LEVEL

For the value of the noise generated by the equipment and further information, contact PIETRO FIORENTINI S.p.A.

ATTENTION!

The obligation to use earmuffs or ear plugs to protect the hearing of qualified professional figures (reference paragraph 2.10) remains in the event that the noise in the installation environment of the equipment (depending on specific operating conditions) exceeds the value of 85 dBA.

4 - DESCRIPTION AND OPERATION

4.1 - GENERAL DESCRIPTION

The RSE - RSV apparatus is a volumetric meter that is applied at the gas distribution networks final redelivery points. The meter incorporates a diaphragm measuring system to measure the volume of gas flowing through it, which can:

- guarantee the consumption detection functions;
- transmit the data as prescribed by current applicable legislation.

The RSE - RSV equipment is a measuring apparatus:

- with accuracy class 1.5 or 1 (on request) as defined in Directive 2014/32/EU (MID);
- which can carry out consumption profiling as required by the Regulatory Authority for Energy, Networks and Environment (ARERA) in resolution 631/2013/R/gas and ratified in the UNI/TS 11291 package of standards.

The main elements of the equipment are (see Fig. 4.3.):

Pos.	Description	Pos.	Description
1	Metrological cover	8	Communication battery compartment
2	Plastic enclosure	9	Communication battery
3	Metal enclosure	10	PCB board
4	LCD display	11	Metrological battery
5	Operator buttons	12	Communication battery connector
6	Inlet pipe connection fitting	13	SIM slot (Trio 2FF)
7	Outlet pipe connection fitting	-	-

Tab. 4.19.

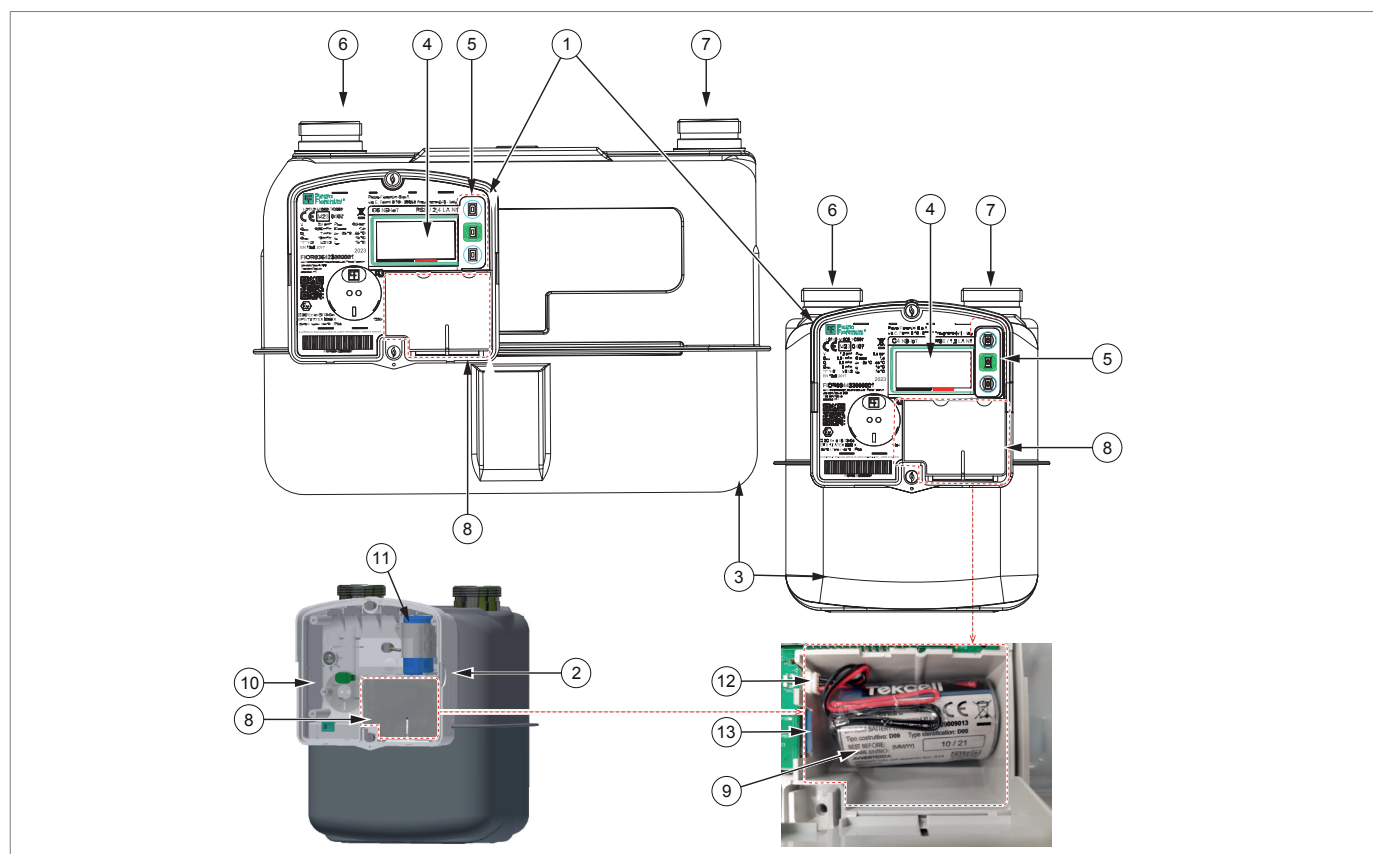

Fig. 4.3. General description RSE - RSV

4.1.1 - POWER SUPPLY DEVICES

The equipment RSE - RSV can only be powered by the specific approved battery packs.

The device uses two distinct battery packs:

- the metrological battery which cannot be replaced in the field, useful for managing the metrological part and local interfaces;
- the communication battery, which can be replaced in the field, useful for managing the remote communication.

Each pack consists of a lithium battery with cables ending with a specific connector, enclosed in a protective sheath.

NOTICE!

For the technical details of the battery packs and the reference operating conditions, refer to paragraph 4.3 “Technical data”.

4.1.1.1 - CONNECTION OF THE POWER SUPPLY DEVICES

NOTICE!

The equipment RSE - RSV is supplied with both battery packs already connected and ready for use in the field.

4.1.1.2 - POWER SUPPLY STATUS

A calculation is made for every battery pack, of the actual consumption, based on:

- the elapsed time;
- the individual functions actually performed (e.g.: switching on the display, pressing buttons, local and remote data transmission, etc);
- the weight in terms of consumption defined for every specific function in the laboratory tests carried out by the Manufacturer;
- 10% remaining charge being reached, an alarm is recorded and shown on the display.

4.1.2 - SHUT-OFF VALVE (OPTIONAL)

NOTICE!

The gas flow shut-off valve is not accessible without causing permanent damage to the meter.

The gas flow shut-off valve is found inside the body of the meter in the inlet fitting, which intercepts the gas flow to the utility for commercial purposes only.

The valve is specifically designed to guarantee the performance required in the UNI/TS 11291 package of standards.

WARNING!

In no way or condition must the valve be considered and used as a device to assure safety conditions in the user's system in case of possible or patent gas leaks.

The valve can provide:

- the actual state of the supply (closed/open valve) to the control microprocessor;
- indications on correct operation.

The valve can be closed:

- via the remote communication channel (e.g.: command sent from the Remote management centre or the CAS – Central Acquisition System);
- when the change of the communication battery pack is not authorised;
- for attempted break-ins;
- when the authorised battery change lasts too long (configurable time threshold);
- in case of no remote communication longer than a configurable time;
- if the residual charge of the metrological battery pack is below the critical level (1%);
- if the equipment management system malfunctions.

The valve is controlled by the meter by checking:

- the physical state (“**Open**” and “**Closed**” values);
- the logic state (“**Re-enabled on opening**” with the physical state at the “**Closed**” valve value).

NOTICE!

Refer to Chapter 5 “User Interface” for the valve opening procedure.

4.1.3 - ACQUISITION OF THE MEASURE

The gas volume measurement (flow rate) is carried out continuously by means of the mechanical system consisting of two measuring chambers (of known volume) with deformable diaphragms, which expand and contract alternately. This movement, induced by the pressure difference between the inlet and outlet passages, is transmitted to a pin that makes a complete turn at every cyclic volume of gas passing through.

The movement of the pin:

- causes the rotation of an encoder;
- is detected by means of two optical sensors.

The system, consisting of an encoder and optical sensors, represents the interface between the measuring mechanics and the calculation and control electronics.

The governing microprocessor:

- drives the detection of optical sensors;
- carries out continuous diagnostic activity to highlight any failures and fraud attempts.

The temperature measurement, required to calculate the volumes at the thermodynamic conditions of reference, is carried out via a temperature sensor, which provides a measurement in Kelvin.

The measurement of the gas temperature is acquired and updated every 30 s.

4.1.4 - EVENTS AND DIAGNOSTICS

With reference to the standards of the UNI/TS 11291 series, the equipment implements in particular the following services:

- detection and reporting of faults (UNI/TS 11291-1);
- functional requirements - events log (UNI/TS 11291-6);
- functional requirements - diagnostics and alarms (UNI/TS 11291-6).

4.1.5 - ACTIVATION AND CONFIGURATION

With reference to the standards of the UNI/TS 11291 series, the equipment implements in particular the following services:

- synchronisation (UNI/TS 11291-1);
- software upgrade (UNI/TS 11291-1);
- control and maintenance of the infrastructure (UNI/TS 11291-1);
- functional requirements - programming (UNI/TS 11291-6);
- functional requirements – operations concerning commissioning and maintenance (UNI/TS 11291-6);
- functional requirements - clock (UNI/TS 11291-6).

4.1.6 - COMMUNICATION INTERFACES

The equipment has two communication interfaces, a local one and a remote one:

Interface	Type	Description
Remote	GPRS model	Modem GPRS quad-band and antenna integrated in the device.
	N1 (NB-IoT) model	Modem NB-IoT multi-band and antenna integrated in the device.
	RF 169 model	Modem Wireless MBus and antenna integrated in the device.
Local	Optical port/infrared	Requires an external device (optical probe) for connection to a local terminal/PC (compliant with IEC 62056-21). The physical protocol used for the ZVEI optical port is DLMS. The asynchronous format and the speed of the optical port are set to the following values: <ul style="list-style-type: none"> • speed: 9600 baud; • data format: 1 (start bit), 8 (data bit), N (no parity), 1 (stop bit). The ZVEI optical port is normally disabled and is activated when the display is switched on.

Tab. 4.20.

4.1.7 - USER INTERFACE

NOTICE!

Refer to chapter 5 in this manual for all information on the user interface.

4.2 - INTENDED USE

4.2.1 - ENVISAGED USE

The RSE - RSV meter is intended for:

Operation	Permitted	Not Permitted	Work environment
Measuring the volume of gas	<ul style="list-style-type: none"> Methane gas, town gas, propane and butane. Gases from the first to the third family (UNI EN 437). Mixtures of Natural Gas and Hydrogen (with the hydrogen component not exceeding 20%). 	Any other type of gas other than permitted.	Application in gas distribution networks final redelivery points for use: <ul style="list-style-type: none"> residential; commercial.

Tab. 4.21.

The equipment referred to was designed to be used exclusively within the limits specified on the nameplate and according to the instructions and limits of use specified in this manual.

Safe work indications are:

- use within the limits stated on the nameplate and in this manual;
- compliance with the user manual procedures;
- routine maintenance to be carried out when and how recommended;
- special maintenance to be carried out if required;
- do not tamper with and/or bypass the safety devices.

4.2.2 - REASONABLY FORESEEABLE MISUSE

Incorrect and reasonably foreseeable misuse means the use of the equipment in a way not foreseen in the phase but which can result from result predictable human behaviour:

- using the equipment in a manner other than that referred to under “**Intended use**”.
- instinctive reaction of an operator in the event of a malfunction, accident or breakdown while using the equipment;
- behaviour resulting from carelessness;
- behaviour resulting from the use of the equipment by unauthorised and unsuitable people (children, disabled);

Any use of the equipment other than the intended use must be previously approved in writing by PIETRO FIORENTINI S.p.A. If no written approval is provided, use shall be considered “**improper**”.

In the event of “improper use”, PIETRO FIORENTINI S.p.A. shall not be held liable for any damage caused to people or property, and any type of warranty on the equipment shall be deemed void.

4.3 - TECHNICAL DATA

General features				
Electronic casing/Container	Polycarbonate			
Casing protection rating	IP55			
Threaded fitting/Connections	ISO 228-1, 1"1/4, also available with connections: 3/4", 7/8", 1", and 2" single coupling			
Maximum working pressure	0.5 bar			
Operative temperature range	from -25 °C to +55 °C			
Gas temperature range	from -25 °C to +55 °C			
Pressure drop at maximum capacity	≤ 2 mbar			
Temperature sensor	Integrated			
Real time clock	RTC always on (accuracy according to IEC 62054-21)			
Firmware	Remotely upgradeable			
Measurement precision	Class 1.5/1 (MID)			
ATEX marking	II 3G Ex ic IIB T3 Gc			
Resistance to high temperatures "T"	Yes			
Environment class Mechanical and Electromagnetic	M2 / E2			
Outdoor use "H3"	Yes			
Flow rate ranges	G 1,6	$Q_{min} = 0,016 \text{ m}^3/\text{h}$	$Q_t = 0,25 \text{ m}^3/\text{h}$	$Q_{max} = 2,5 \text{ m}^3/\text{h}$
	G2,5	$Q_{min} = 0,025 \text{ m}^3/\text{h}$	$Q_t = 0,4 \text{ m}^3/\text{h}$	$Q_{max} = 4 \text{ m}^3/\text{h}$
	G4	$Q_{min} = 0,04 \text{ m}^3/\text{h}$	$Q_t = 0,6 \text{ m}^3/\text{h}$	$Q_{max} = 6 \text{ m}^3/\text{h}$
	G6	$Q_{min} = 0,06 \text{ m}^3/\text{h}$	$Q_t = 1,0 \text{ m}^3/\text{h}$	$Q_{max} = 10 \text{ m}^3/\text{h}$

Tab. 4.22.

Communication	
Local interface	<ul style="list-style-type: none"> Infrared optical port (IEC 62056-21). Speed: 9600 baud.
Remote interface	<ul style="list-style-type: none"> WM-Bus @ 169Mhz mode-N2 (EN 13757). GPRS quadband. NB-IoT: LTE band 20 (default), 3, 5, 8, 25, 28.
Communication protocol	Application protocol: DLMS/COSEM (data model according to UNI/TS 11291).

Tab. 4.23.

Battery pack features			
Type	Service life (with standard consumption profile)	Identifier	Type
Metrology	> 15 years	-	Non-rechargeable Li-SOCl ₂ 3,6V
Transmission RF169*	> 15 years	C01**	Non-rechargeable Li-SOCl ₂ 3,6V
GPRS transmission*	> 8 years	D09**	Non-rechargeable Li-SOCl ₂ 3,6V
NB-IoT* transmission	> 20 years	D09**	Non-rechargeable Li-SOCl ₂ 3,6V

* Replaceable in the field

** The "identifier type" of the battery pack must be specified when ordering new parts to be replaced in the field.

Tab. 4.24.

5 - USER INTERFACE

5.1 - GENERAL DESCRIPTION

The following paragraphs describe the interaction methods between operator and user interface, and the meanings of the various fields on the display.

The user interface consists of the following main components, through which it is possible to consult the data provided by the device (see Fig.5.4.):

Pos.	Element	Description
1	LCD display black and white with segments and icons	Allows you to consult the data provided by the equipment.
2	Optical Interface	It allows on-site communication with a terminal device.
3	Scroll keys	They allow you to browse through the pages and data menus of the display, specifically: a. top button: scroll up function; b. central text (green): function for switching on the display ('ON') and confirming data ('Enter'); c. bottom button: scroll down function.

Tab. 5.25.

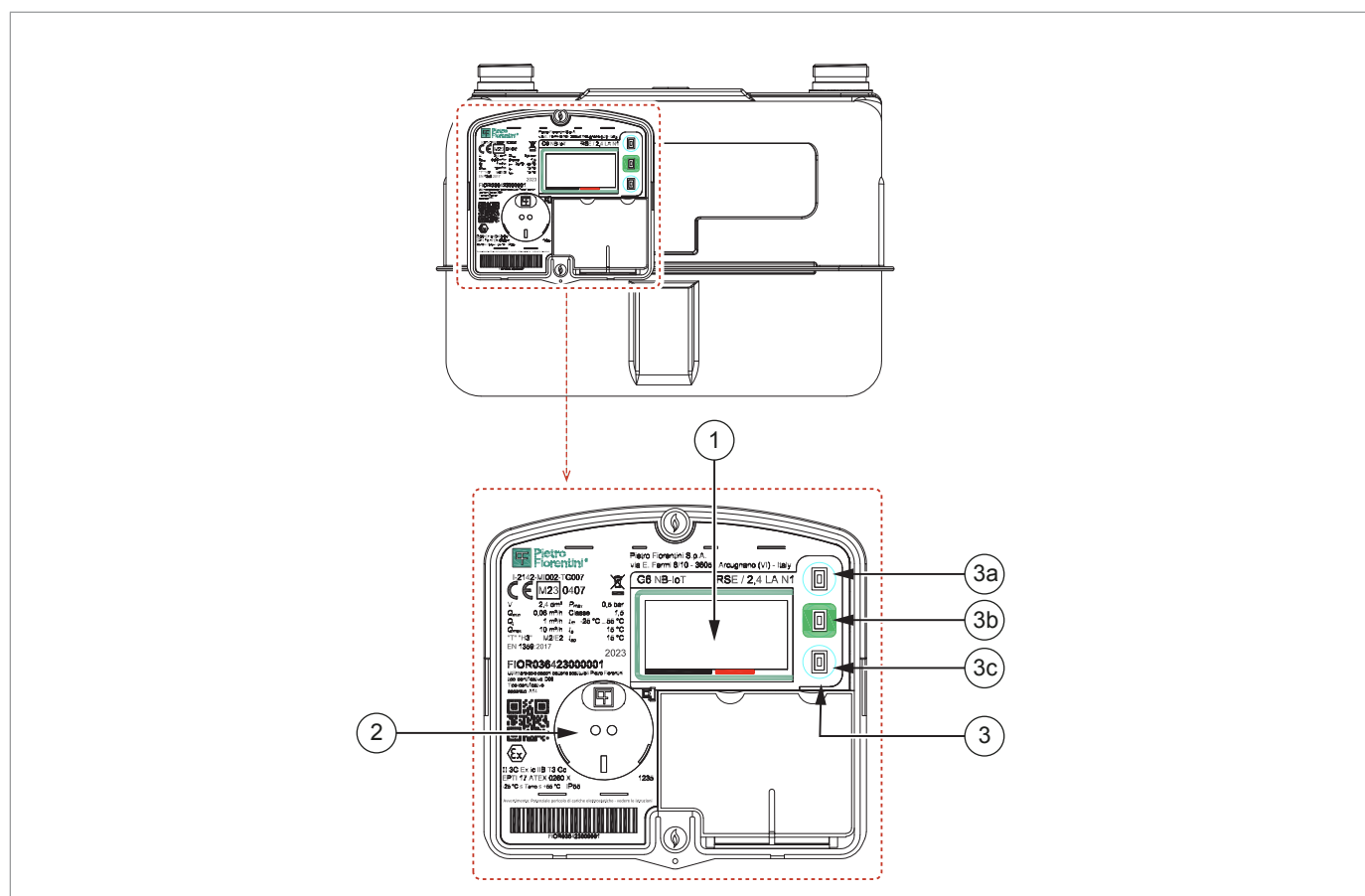

Fig. 5.4. User interface RSE - RSV

5.2 - LCD DISPLAY DESCRIPTION

! NOTICE!

To assure a long battery life, the display is usually kept off.

With the display off, turn it on by pressing the “Enter” key for at least 1 s.

The display automatically switches off after 2 minutes of inactivity.

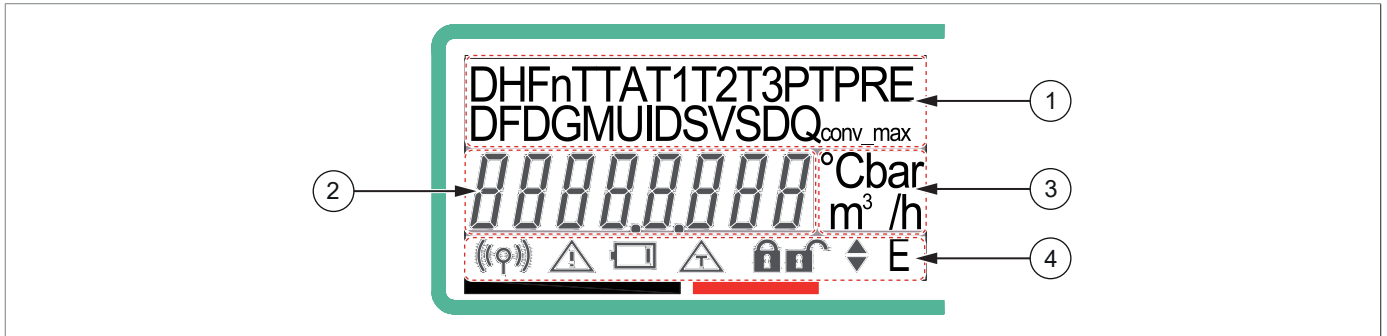

Fig. 5.5. LCD display RSE - RSV

Tab. 5.26. describes the main areas on the display:

Pos.	Name	Description
1	Menu field	Each menu can be identified with a letter or a combination of letters and numbers (see section 5.2.1).
2	Alphanumeric field	8 7-segment digits displaying the value associated with the menu displayed at Pos. 1 .
3	Units of measurement field	Consult paragraph 5.2.2.
4	Icons and alarms field	Consult paragraph 5.2.3.

Tab. 5.26.

5.2.1 - MENU FIELD

Icon	Description
T	Volume totaliser at the reference conditions.
TA	Volume totaliser in alarm.
T1	Volume totaliser under reference conditions for range 1.
T2	Volume totaliser under reference conditions for range 2.
T3	Volume totaliser under reference conditions for range 3.
PRE	Totalisers T, TA, T1, T2 , T3 concerning previous billing period.
DF	End date of last billing period. It expresses the date which the data of the previous period refer to (T/TA/T1/T2/T3 PRE).
DG	Diagnostics.
MU	User message.
ID	Redelivery point identifier.
SV	Valve status.
Qconv_max	Maximum conventional flow rate referring to the current billing period.
Qconv_max PRE	Maximum current conventional flow rate referring to the previous billing period.
PT	Current fee scheme identifier.
PT PRE	Fee scheme identifier referring to the previous billing period.
SD	Status of the device.
D	Current date: DD-MM-YY format.
H	Current time: hh-mm-ss format.
Fn	Active tariff range.

Tab. 5.27.

5.2.2 - UNITS OF MEASUREMENT FIELD

According to the selection, it indicates the unit of measurement in which the value in the alphanumeric field is expressed, specifically:

Icon	Description
°C	Temperature unit of measurement.
bar	Pressure unit of measurement.
m³	Volume unit of measurement.
m³/h	Flow rate unit of measurement.

Tab. 5.28.

NOTICE!

In the RSE meter, all volume and flow rate values shown on the display as m³ or m³/h are to be understood as volumes or flow rates converted to the basic reference conditions (Sm³ and Sm³/h).

5.2.3 - ICONS AND ALARMS FIELD

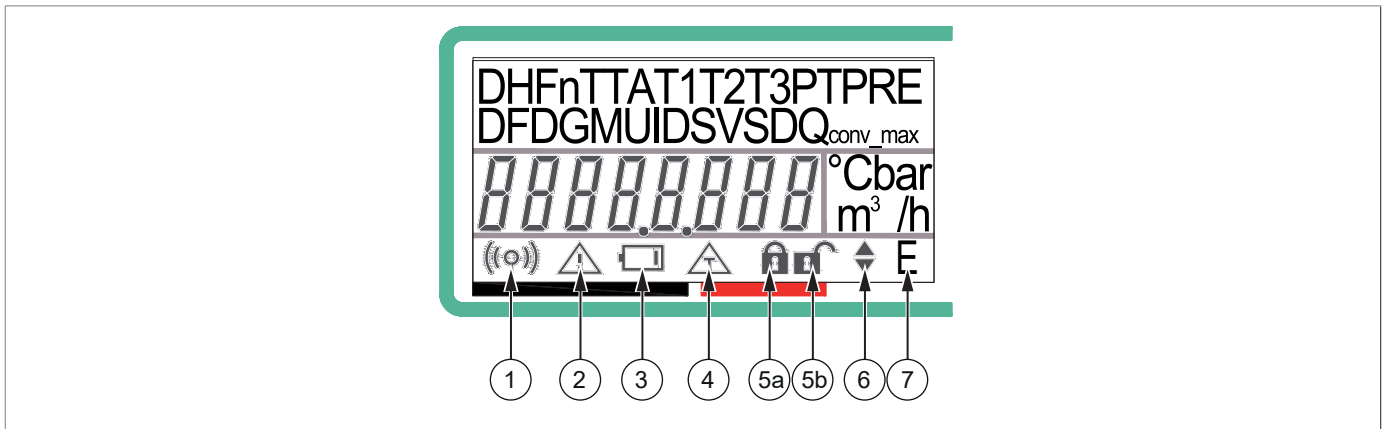

Fig. 5.6. Icons and alarms field



Tab. 5.29. describes the icons present:

Pos.	Name	Description
1	Communication	When active, indicates a remote communication session in progress.
2	General alarm	When the icon is: <ul style="list-style-type: none"> on and steady, it indicates the presence of an alarm condition. The alarm has been recorded and is currently present; flashing, it indicates the presence of a passed alarm condition. The alarm has been recorded and ended but has not yet been read and recovered by remote communication; off, no current alarm condition.
3	Low battery	If active, it indicates the low charge level (<10%) of at least one of the battery packs.
4	Temperature alarm	When the icon is: <ul style="list-style-type: none"> on and steady, it indicates the presence of an alarm condition. The alarm has been recorded and is currently present; flashing, it indicates the presence of a passed alarm condition. The alarm has been recorded and ended but has not yet been read and recovered by remote communication; off, no current alarm condition.
5	Valve status	The valve is: <ul style="list-style-type: none"> closed: Val 20 C (5a); re-enabled: Val 40 R (5a); open: Val 00 A (5b).
6	Available scrolling keys	Indicates, when active, that progress keys are available to navigate sub-menus.
7	“Enter” key available	Indicates, when active, that the 'Enter' key is available.

Tab. 5.29.

5.3 - START-UP PROCEDURE

Under normal operating conditions, the display is completely off. Tab. 5.30. shows the procedure for switching on the interface:

Step	Action
1	Press the green 'Enter' button to switch on the display. <div style="border: 1px solid black; padding: 5px; margin-top: 5px;">  NOTICE! Upon switch-on, a 'lamp test' is performed, lasting approximately 3 sec., during which all fields will be lit to check for faulty segments or icons. </div>
2	At the end of the 'lamp test', the first page of the 'menu field' is displayed. <div style="border: 1px solid black; padding: 5px; margin-top: 5px;">  NOTICE! See section 5.4 for menu navigation. </div>
3	Navigating the interface.

Tab. 5.30.

5.4 - NAVIGATION PROCEDURE

Within the interface, information is organised in menus. The various menus:

- are identified by the icons shown on the display in the 'menu field' area (see section 5.2.1);
- are displayed in succession.

The menu sequence can be navigated either downwards or upwards via the up and down scroll keys. By pressing the button:

- top, you return to the previous menu;
- bottom, you move on to the next menu.

The activation of the letter 'E' in the icons and alarms field indicates the presence of sub-menus. Press:

- the green 'Enter' button to display the sub-menu;
- the up and down keys to navigate within the sub-menu.

5.5 - SEQUENCE OF AVAILABLE MENUS

The menu display sequence is circular. Once the end is reached, the display continues in the order defined below.

5.5.1 - VOLUME TOTALISER AT THE REFERENCE CONDITIONS

Abbreviation	Format	Unit	Sub-menu	Image on Display
T	5 integer digits and 3 decimal digits	m ³	-	T 0 1998.186 m ³

Tab. 5.31.

NOTICE!

For metrological verification purposes, it is possible to activate the display of the totaliser log in high resolution (see section 5.5.20).

5.5.2 - VOLUME TOTALIZER IN ALARM

Abbreviation	Format	Unit	Sub-menu	Image on Display
TA	5 integer digits and 3 decimal digits	m ³	-	TA 00000.000 m ³

Tab. 5.32.

5.5.3 - VOLUME TOTALISER IN TARIFF RANGE 1

Abbreviation	Format	Unit	Sub-menu	Image on Display
T1	5 integer digits and 3 decimal digits	m ³	-	T1 0 1998.186 m ³

Tab. 5.33.

5.5.4 - VOLUME TOTALISER IN TARIFF RANGE 2

Abbreviation	Format	Unit	Sub-menu	Image on Display
T2	5 integer digits and 3 decimal digits	m ³	-	T2 00000.000 m ³

Tab. 5.34.

5.5.5 - VOLUME TOTALISER IN TARIFF RANGE 3

Abbreviation	Format	Unit	Sub-menu	Image on Display
T3	5 integer digits and 3 decimal digits	m ³	-	<p style="text-align: center;">T3</p> 

Tab. 5.35.

5.5.6 - VOLUME TOTALISER AT REFERENCE CONDITIONS (END OF PREVIOUS PERIOD)

Abbreviation	Format	Unit	Submenu	Image on Display
T PRE	5 integer digits and 3 decimal digits	m ³	-	<p style="text-align: center;">T PRE</p> 

Tab. 5.36.

5.5.7 - VOLUME TOTALISER IN ALARM (END OF PREVIOUS PERIOD)

Abbreviation	Format	Unit	Sub-menu	Image on Display
TA PRE	5 integer digits and 3 decimal digits	m ³	-	<p style="text-align: center;">TA PRE</p> 

Tab. 5.37.

5.5.8 - VOLUME TOTALISER IN TARIFF RANGE 1 (END OF PREVIOUS PERIOD)

Abbreviation	Format	Unit	Sub-menu	Image on Display
T1 PRE	5 integer digits and 3 decimal digits	m ³	-	<p style="text-align: center;">T1 PRE</p> 

Tab. 5.38.

5.5.9 - VOLUME TOTALISER IN TARIFF RANGE 2 (END OF PREVIOUS PERIOD)

Abbreviation	Format	Unit	Sub-menu	Image on Display
T2 PRE	5 integer digits and 3 decimal digits	m ³	-	<p style="text-align: center;">T2 PRE</p> 

Tab. 5.39.

5.5.10 - VOLUME TOTALISER IN TARIFF RANGE 3 (END OF PREVIOUS PERIOD)

Abbreviation	Format	Unit	Sub-menu	Image on Display
T3 PRE	5 integer digits and 3 decimal digits	m ³	-	T3 PRE 00000,000 m ³

Tab. 5.40.

5.5.11 - PERIOD END DATE

Abbreviation	Format	Unit	Sub-menu	Image on Display
DF	dd-mm-yy	-	-	DF 09-02-13

Tab. 5.41.

5.5.12 - DIAGNOSTICS

Abbreviation	Format	Unit	Sub-menu	Image on Display
DG	4 digits (Hexadecimal Code)	-	-	

Tab. 5.42.

The coding of the information complies with what is defined in UNI/TS 11291-11/-12. The 16 bits shown in Tab. 5.43. are represented in hexadecimal format (0 - F) in groups of 4:

Bit	Description	Format groups
15	Reserved	4°
14	1 = Valve closed, but there are leaks	
13	1 = Sync active	
12	1 = Valve operation fault	
11	1 = Daylight Saving Time on	3°
10	1 = Tampering detected	
9	1 = Battery level critical	
8	1 = Battery level lower than 10%	
7	1 = Device not configured or in maintenance; 0 = Device configured	2°
6	1 = Memory error	
5	1 = Flow rate error	
4	1 = Generic device error	
3	1 = Measurement algorithm error	1°
2	1 = Metrological Event Log \geq 90%	
1	1 = Metrological Event Log full	
0	1 = Clock synchronisation failed	

Tab. 5.43.

Diagnostic example:

	Meaning				
Format group:	4°	3°	2°	1°	<ul style="list-style-type: none"> Bit 1 = 1 Metrological Event Log complete. Bit 11 = Daylight Saving Time on
Hexadecimal encoding:	0	8	0	2	
Binary encoding:	0000	1000	0000	0010	
Active bit:	-	11	-	1	

Tab. 5.44.

5.5.13 - USER MESSAGE

Abbreviation	Format	Unit	Sub-menu	Image on Display
MU	Text (max. 100 characters)	-	-	

Tab. 5.45.

5.5.14 - REDELIVERY POINT (PDR) ID

Abbreviation	Format	Unit	Sub-menu	Image on Display
ID	14 digits	-	"E"	

Tab. 5.46.

Press the green 'Enter' key to activate the scroll mode and check the 14-character Redelivery Point (PDR) field.

5.5.15 - VALVE STATUS

Abbreviation	Format	Unit	Sub-menu	Image on Display
SV	-	-	"E"	

Tab. 5.47.

Press the green 'Enter' key to access the submenus shown in Tab. 5.48.:

Id.	Operation	Description
VAL	00 A	Valve open
	20 C	Valve closed
	40 r	Valve enabled to open
VR	Nn	Time remaining
VT	Nn	Number of attempts
VP	Enter Password/Opening	VP ----- = Opening not enabled. VP PSSd = Opening not enabled but can be enabled by entering password. VP PUD0 --- = Enter password to enable valve opening. VP OPEn = Opening enabled, press the green 'Enter' key to confirm valve opening.
VL	Nn	Leak test and result (dm ³)

Tab. 5.48.

To enter the password:

- select numbers using the up and down scroll keys;
- press the green 'Enter' key to confirm.

To perform the test, press the green 'Enter' key.

5.5.16 - MAXIMUM CONVENTIONAL FLOW RATE (CURRENT PERIOD)

Abbreviation	Format	Unit	Sub-menu	Image on Display
Qconv_max	2 integer digits and 3 decimal digits	m ³ /h	-	

Tab. 5.49.
5.5.17 - MAXIMUM CONVENTIONAL FLOW RATE (PREVIOUS PERIOD)

Abbreviation	Format	Unit	Sub-menu	Image on Display
Qconv_max PRE	2 integer digits and 3 decimal digits	m ³ /h	-	

Tab. 5.50.
5.5.18 - CURRENT FEE SCHEME IDENTIFIER

Abbreviation	Format	Unit	Sub-menu	Image on Display
PT	2 integer digits and 3 decimal digits	m ³ /h	-	

Tab. 5.51.
5.5.19 - PREVIOUS FEE SCHEME IDENTIFIER

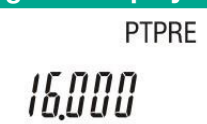
Abbreviation	Format	Unit	Sub-menu	Image on Display
PTPRE	2 integer digits and 3 decimal digits	m ³ /h	-	

Tab. 5.52.

5.5.20 - STATUS OF THE DEVICE

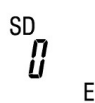
Abbreviation	Format	Unit	Sub-menu	Image on Display
SD	1 digit	-	"E"	

Tab. 5.53.

Value	Description
SD 0	Normal/Configured
SD 1	Maintenance
SD 3	Not Configured

Tab. 5.54.

In maintenance status, the device does not record events. Other values are only possible during factory production. Press the green 'Enter' key to switch to the service sub-menu.

5.5.20.1 - SERVICE SUB-MENU

The menu structure is shown in Tab. 5.55.:

Prefix	Description
Count Lo	<p>Resolution of totalisers T and TA.</p> <ol style="list-style-type: none"> 1. Press the green 'Enter' key to activate high resolution (the display will show 'Count Hi') to 4 integer digits + 4 decimal digits. 2. Press the green 'Enter' key again to return to the default resolution ('Count Lo') of 5 integer digits + 3 decimal digits. <div style="border: 1px solid blue; padding: 5px; margin-top: 10px;"> <p> NOTICE!</p> <p>If no selection is made, the resolution automatically returns to the default value (5 integer digits and 3 decimal digits) at 00:00 the next day.</p> </div>
T ----- °C	Current temperature of the gas (refreshed every 2 sec.).
Set Lcd	<p>LCD display contrast setting.</p> <ol style="list-style-type: none"> 1. Press the green 'Enter' key. 2. Use the up and down keys to adjust the contrast. 3. Press the green 'Enter' key again to confirm adjustment.
CC	<p>Display of result of last remote communication attempt (GPRS/NB-IoT):</p> <ul style="list-style-type: none"> • CC oo dn = positive outcome. • CC 88 dn = negative outcome or incomplete/partial session. <p>Pressing the 'Enter' key forces a new remote communication attempt (GPRS/NB-IoT). A 4-digit password is required for this operation.</p> <p>During a communication session, the display shows:</p> <ul style="list-style-type: none"> • 'CC - up'. <p>At the end of the session, one of the possible outcomes of the remote communication attempt will be displayed.</p>
CSQ	<p>Radio signal value (RSSI) for the last connection attempt:</p> <ul style="list-style-type: none"> • CSQ = 99 : uncomputed signal level. • CSQ = 0 : signal absent. • CSQ = 1 : minimum theoretical signal level (RSSI = -111dBm). • CSQ = 2 - 30 : RSSI signal values between minimum and maximum levels. • CSQ = 31 : maximum theoretical signal level (RSSI = -51dBm).

Prefix	Description
ECL	ECL coverage level value (NB-IoT models only): <ul style="list-style-type: none"> ECL = 0 : optimum coverage level. ECL = 1 : low coverage level. ECL = 2 : marginal coverage level.
Iccid	Press the green 'Enter' key to display the Iccid code of the inserted SIM card. Use the up and down keys to scroll through the codes. Press the green 'Enter' key to leave the display.
back	Press the green 'Enter' key to exit the current sub-menu.

Tab. 5.55.

5.5.21 - DATE

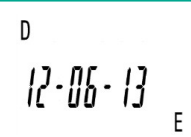
Abbreviation	Format	Unit	Sub-menu	Image on Display
D	dd-mm-yy	-	"E"	

Tab. 5.56.

Press the green 'Enter' key to switch to the firmware sub-menu.

5.5.21.1 - FIRMWARE SUB-MENU

Press the scroll keys to scroll the parameters in sequence, identified by their own prefix, shown in Tab.5.57.:

Prefix	Description
01I	Metrological Firmware (LR) - CRC16
02I	Metrological Firmware (LR) - Firmware release
03b	Metrological Firmware (LR) -Bench boot section 0 - CRC16
04b	Metrological Firmware (LR) -Bench boot section 0 - Firmware release
05b	Metrological Firmware (LR) -Bench boot section 1 - CRC16
06b	Metrological Firmware (LR) -Bench boot section 1 - Firmware release
07n	Non-Metrological Firmware (NLR) - CRC16
08n	Non-Metrological Firmware (NLR) - Firmware release
-	Firmware update date (00-00-00 if default version)
-	Firmware update time (00-00-00 if default version)
11	Days (d) of operation
12	Hours, minutes and seconds (h-m-s) of operation
13	Days (d) of operation in active status
14	Hours, minutes and seconds (h-m-s) of operation in active status
15	LR parameters editing events meter
16	FW upgrade events meter
17	FW upgrade not completed successfully events meter
18	Firmware restart events meter
19	CRC errors relative to LR data meter
20	Fraud events meters

Tab. 5.57.

5.5.22 - HOUR

Abbreviation	Format	Unit	Sub-menu	Image on Display
H	hh-mm-ss	-	“E”	H 18-30

Tab. 5.58.

The firmware loaded at the factory is the first record (date and time set to 00-00-00).

If the download fails, 4 dashes (“----”) are displayed, followed by the date and time of the attempt.

Press the green 'Enter' key to access the sub-menu displaying the history of the last 32 firmware updates.

For each firmware update, a block of three submenus is added:

- CRC16 LR of the firmware.
- Updating date.
- Updating time.

5.5.23 - CURRENT RATE

Abbreviation	Format	Unit	Sub-menu	Image on Display
Fn	1 digit	-	“E”	Fn }

Tab. 5.59.

Digit format	Description
1	Range 1
2	Range 2
3	Time slot 3

Tab. 5.60.

Press the green 'Enter' key to access the sub-menu displaying the history of the last 128 changed parameters.

For each changed parameter, a block of four sub-menus is added:

- ID (1 = Basic temperature; 2 = Fallback temperature).
- Value (old)
- Date of change.
- Time of the change.



5.6 - ALARMS

The lighting of the alarm icon on the display indicates that one or more of the following error conditions are in progress:

- error in the measuring system;
- unauthorised access to the device or failed battery replacement attempt;
- integrity error of the firmware code.

5.7 - OPENING THE SHUT-OFF VALVE

The previously closed shut-off valve must always change from the physical '**Closed**' state to the logical '**Re-enabled on opening**' state; this changeover occurs through the receipt of the remote or local command for re-enabling on opening. Proceed as described in Tab.5.61. to open the shut-off valve from the user interface:

Step	Action
1	<p>Check that you have obtained authorisation from the Management Centre or CAS.</p> <div style="border: 1px solid black; padding: 5px;">  NOTICE! The authorisation is bound to a time limit within which the operation must be performed and to a maximum of available attempts. </div> <p>In the 'SV' valve menu, 'VAL 40 r' identifies the opening authorisation.</p>
2	<p>Press "Enter" to access the sub-menu.</p> <div style="border: 1px solid black; padding: 5px;">  NOTICE! According to the relative configuration, the opening of the valve may be subject to a password being entered. </div>
3	Verify that 'OK' appears on the display after opening.
4	Check the display in the " SV " valve menu, of the " VAL 00 r " writing, which identifies the valve opening.

Tab. 5.61.

If enabled, the leak test (the time for checking the presence of flow, see reference UNI/TS 11291) is performed within 360 seconds of opening.

If the set flow rate threshold is exceeded, the valve is returned to the closed position with the status '**Re-enabled on opening**' (VAL 40 r), allowing the tightness of the system to be checked and a subsequent re-opening attempt to be made.

After the set number of attempts, the valve will return to its physical '**Closed**' status (Val 20 C).

6 - TRANSPORT AND HANDLING

6.1 - SPECIFIC WARNINGS FOR TRANSPORT AND HANDLING

NOTICE!

Transport and handling must be carried out in compliance with the regulations in force in the country of installation by personnel who are:

- qualified (specially trained);
- who are familiar with accident prevention and workplace safety regulations;
- authorised to use lifting equipment.

Transport and handling

Operator qualification	<ul style="list-style-type: none"> • Installer.
PPE required	 <p>WARNING!</p> <p>The PPE listed in this table is related to the risk associated with the equipment. For the PPE required to protect against risks associated with the workplace, installation or operating conditions, please refer to:</p> <ul style="list-style-type: none"> • the regulations in force in the country of installation; • <u>any information provided by the Safety Manager at the installation facility.</u>
Weights and dimensions of the equipment	For dimensions and weights please refer to section 6.3 and section 6.4.

Tab. 6.62.

6.1.1 - PACKAGING AND FASTENERS USED FOR TRANSPORT

The transport packaging is designed and manufactured to avoid damage during normal transport, storage and handling. The equipment must be kept in the packaging until installation.

Upon receiving the equipment, please:

- make sure that no part has been damaged during transport and/or handling;
- immediately report any damage found to PIETRO FIORENTINI S.p.A..

NOTICE!

PIETRO FIORENTINI S.p.A. shall not be liable for any damage to people or property caused by accidents due to failure to comply with the instructions provided in this manual.

Tab. 6.63. describes the types of packaging used:

Ref.	Type of packaging	Image
A	Single cardboard box	

Tab. 6.63.

6.2 - PACKAGING CONTENT

NOTICE!

The EC declaration of conformity is attached to the transport document of the equipment.

The packaging contains:

Description of content

RSE - RSV gas meter including:

- battery packs (metrology and communication);
- 2 plugs for the protection of the connection fittings.

NOTICE!

- **The batteries are already connected electrically in their operating housing.**
- **It is recommended to keep the protective caps in place until the equipment is assembled.**

Tab. 6.64.

NOTICE!

The use, maintenance and warning manual can be downloaded from the Manufacturer's website: <https://www.fiorentini.com>

6.3 - PHYSICAL CHARACTERISTICS RSE-RSV (1.2 LA)

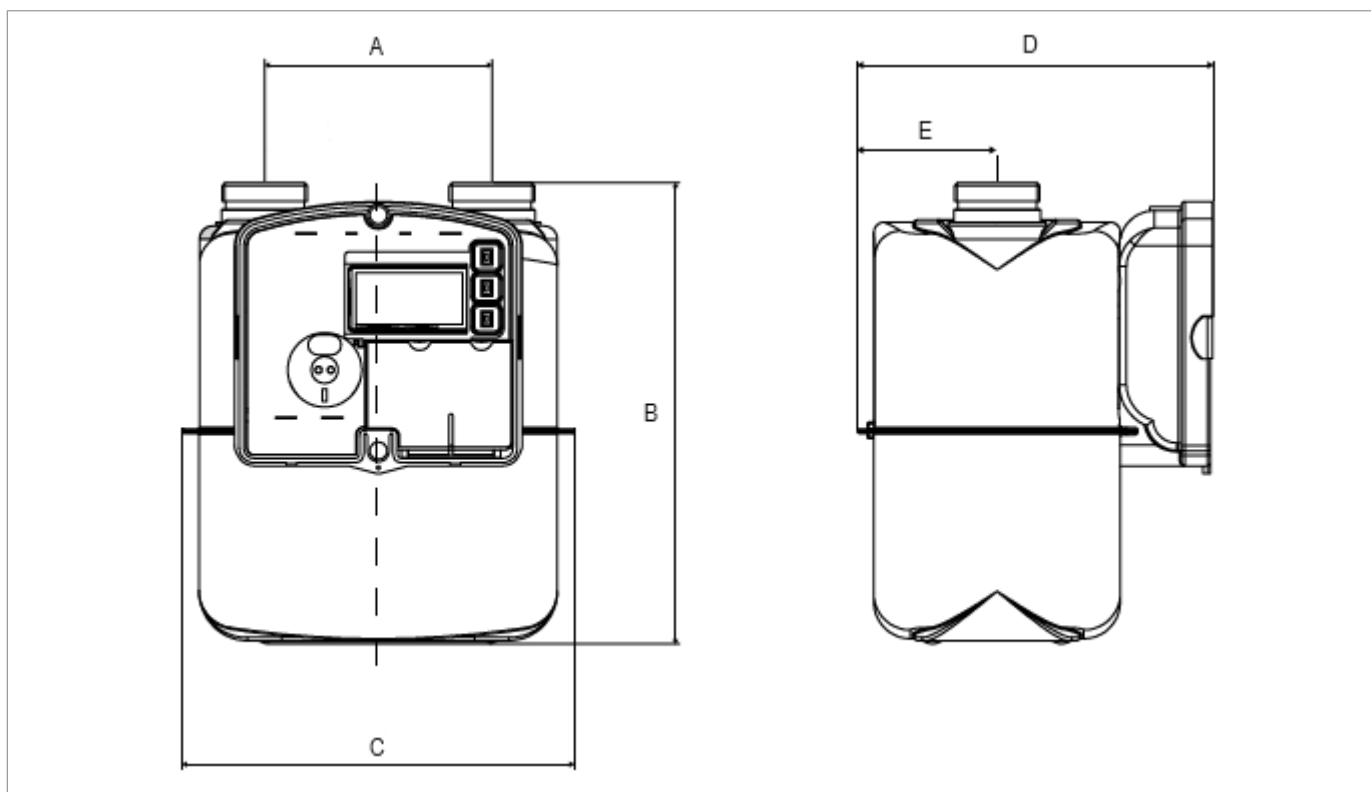

Fig. 6.7. Dimensions RSE - RSV (1.2 LA)

Overall dimensions	
Ref.	Dimensions [mm]
A	110
B	223
C	190
D	172,5 (standard) 167.5 (on request for RSV model)
E	67,7

Tab. 6.65.

Weights [kg]	
Without packaging	1.9
Including packaging	2.1

Tab. 6.66.

6.4 - PHYSICAL CHARACTERISTICS RSE-RSV (2.4 LA)

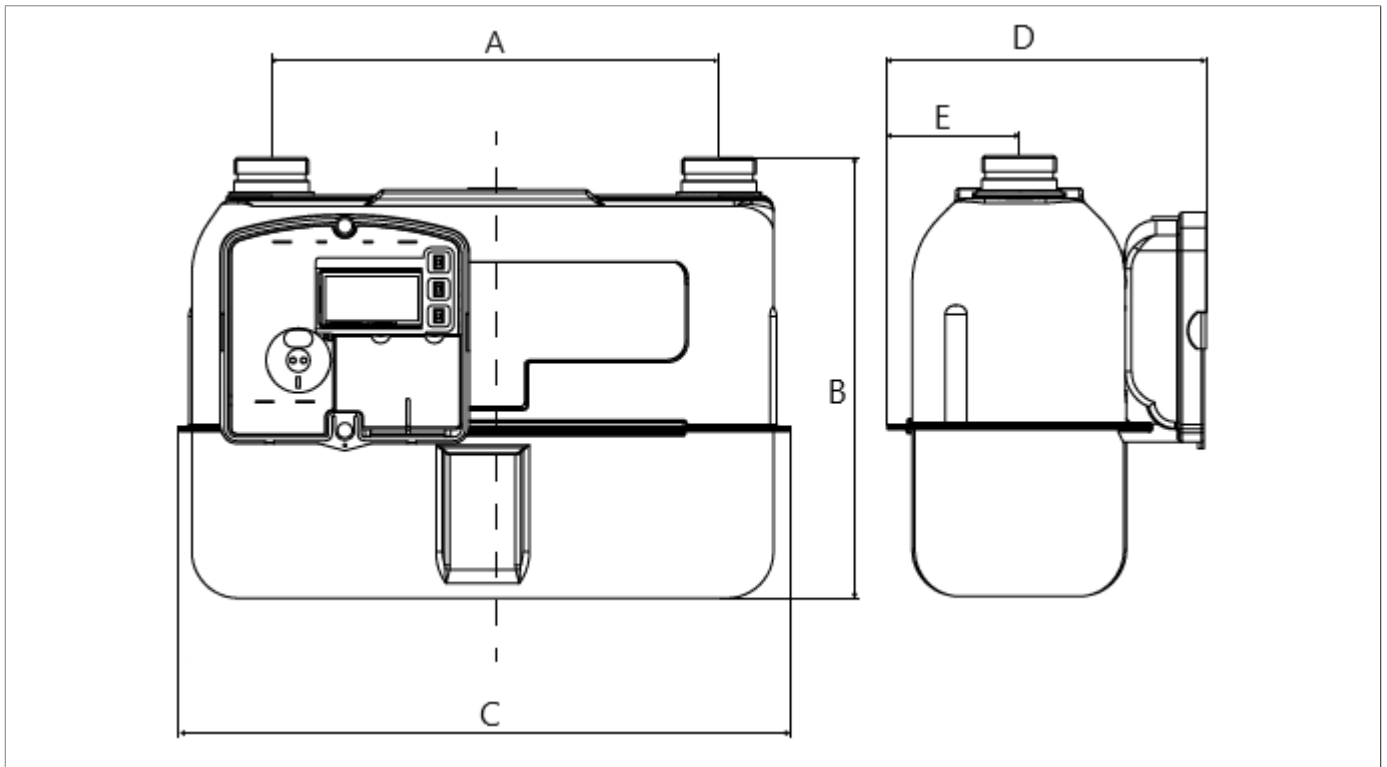

Fig. 6.8. Dimensions RSE - RSV (2.4 LA)

Overall dimensions	
Ref.	Dimensions [mm]
A	250
B	246
C	341,5
D	179
E	74

Tab. 6.67.

Weights [kg]	
Without packaging	3.4
Including packaging	3.8

Tab. 6.68.

6.5 - EQUIPMENT ANCHORING AND LIFTING METHOD

HAZARD!

Using lifting equipment (if necessary) for unloading, carrying and handling packages is reserved only for skilled operators who have been properly trained (and are appropriately qualified if required by the regulations in force in the country of installation) and are familiar with:

- accident prevention rules;
- workplace safety provisions;
- lifting equipment features and limits.

HAZARD!

Before handling a load, make sure that its weight does not exceed the load capacity of the lifting equipment (and any other lifting tools) specified on the specific plate.

ATTENTION!

Before moving the equipment:

- remove any movable or hanging component or firmly secure it to the load;
- protect fragile equipment;
- check that the load is stable;
- make sure to have perfect visibility along the route.

6.5.1 - FORKLIFT HANDLING METHOD

HAZARD!

It is forbidden to:

- Do not transit under suspended loads;
- Do not move the load over the personnel operating in the site/plant area.

WARNING!



The following is not allowed on forklifts:

- carrying passengers;
- lifting people.

WARNING!

During all handling operations, pay close attention to avoid impact or vibrations of the equipment batteries.

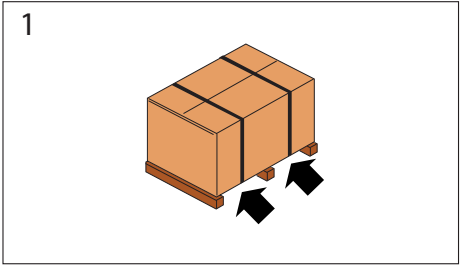
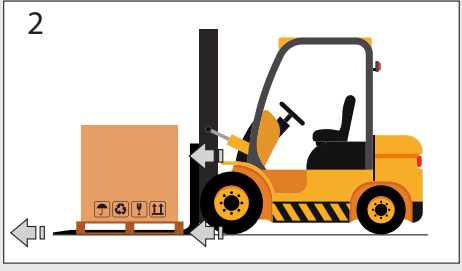

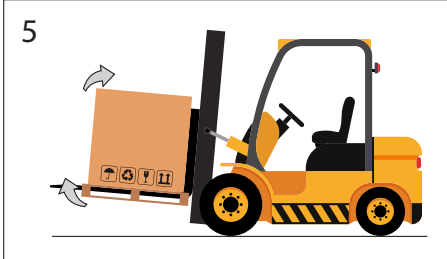

If cardboard boxes (single or multiple) are carried on a pallet, proceed as indicated in Tab. 6.69.:

Step	Action	Image
1	Place the forks of the forklift under the load surface.	
2	Make sure that the forks protrude from the front of the load (by at least 5 cm), far enough to eliminate any risk of the transported load tipping.	
3	Raise the forks until they are touching the load. NOTICE! Fasten the load to the forks with clamps or similar devices if required.	
4	Slowly lift the load by a few dozen centimetres and check its stability, making sure that the centre of gravity of the load is at the centre of the lifting forks.	

Step	Action	Image
5	Tilt the mast backwards (towards the driver's seat) to help the over-turning moment and to ensure greater load stability during transport.	
6	Adjust transport speed according to the type of floor and load, avoiding sudden manoeuvres. ⚠ WARNING! In case of: <ul style="list-style-type: none"> • obstacles along the path; • particular operating situations; hinder operator visibility, the assistance of a ground operator is required, standing outside the range of action of the lifting equipment, with the task of signalling.	-
7	Place the load in the chosen installation area.	-

Tab. 6.69.

6.6 - PACKAGING REMOVAL

Packaging removal	
Operator qualification	<ul style="list-style-type: none"> Installer.
PPE required	<div style="display: flex; align-items: center;">     </div> <div style="background-color: #f4a460; padding: 5px; margin-top: 10px;"> <p>⚠ WARNING!</p> </div> <p>The PPE listed in this table is related to the risk associated with the equipment. For the PPE necessary to protect against risks associated with the workplace or operating conditions, please refer to:</p> <ul style="list-style-type: none"> the regulations in force in the country of installation; <u>any information provided by the Safety Manager at the installation facility.</u>

Tab. 6.70.

To unpack the cardboard boxes (single or multiple) supported by a pallet, proceed as described in Tab. 6.71.:

Step	Action
1	Remove the stretch film around the pallet.
2	Remove the 4 support corners.
3	Move the boxes of the equipment from the pallet to their intended place. <div style="border: 1px solid #0070c0; padding: 5px; margin-top: 10px;"> <p>! NOTICE!</p> <p>Have at least 2 operators manually move the packages if required due to their dimensions/weight.</p> </div>

Tab. 6.71.

! NOTICE!

After removing all packaging materials, check for any anomalies.

If there are anomalies:

- do not install the equipment;
- contact PIETRO FIORENTINI S.p.A. and specify the details provided on the equipment nameplate.

⚠ WARNING!

The single piece of equipment is contained in a specifically created cardboard box.

Avoid taking the equipment out of the box before its installation.

6.6.1 - PACKAGING DISPOSAL

! NOTICE!

Sort the various materials making up the packaging and dispose of them in compliance with the regulations in force in the country of installation.

6.7 - STORAGE AND ENVIRONMENTAL CONDITIONS

WARNING!

Protect the equipment from blows and impacts, even accidental, until it is installed.

NOTICE!

The meters must be stored in an upright position.

If the equipment needs to be stored for an extended period, the minimum environmental conditions for the intended storage are provided in Tab.6.72. Compliance with these conditions will guarantee the declared performance:

Conditions	Data
Maximum storage period	A maximum storage period is not defined as it is only limited by the life span of the product.
Storage temperature	from -25°C to +60°C
Relative humidity	95%

Tab. 6.72.

6.7.1 - STORAGE OF THE SPARE BATTERIES

Any spare battery packs ordered must be stored:

- in their original packaging or alternatively in ADR compliant packaging, by placing the containers at ground level (do not stack above 1.2 m);
- in a place with a temperature $\leq 30^{\circ}\text{C}$ in order to preserve its electrical characteristics;
- away from flammable material, water and rain, corrosive agents, heat sources;
- in the absence of direct sunlight;
- away from metal objects;
- so as to prevent any accidental movement;
- so as to prevent their terminals from bearing the weight of other elements stacked on them.

Battery packs must not be stored:

- with damaged batteries;
- with exhausted batteries.

Replacement battery packs must be installed within a period of time after delivery, which will be specified by the Manufacturer at the time of shipment.

NOTICE!

The packages are labelled in accordance with ADR, i.e. with a diamond shape on the side and code UN3090.



7 - INSTALLATION

7.1 - GENERAL WARNINGS

 **WARNING!**

The installation must be performed by qualified personnel, in compliance with the provisions in force concerning safety.

 **WARNING!**

For the safe use of the equipment, respect the permitted environmental conditions and comply with the data shown on the nameplate.

 **WARNING!**

It is strictly forbidden to make any modifications to the equipment.

 **WARNING!**

PIETRO FIORENTINI S.p.A. is not liable for damage caused by incorrect installation of the equipment and/or otherwise different from that indicated in this manual.

7.2 - INSTALLATION PRE-REQUISITES

7.2.1 - ALLOWED ENVIRONMENTAL CONDITIONS

 **NOTICE!**

For details on the allowed environmental conditions (temperature range and classification) refer to paragraph 4.3 “Technical data”.

 **WARNING!**

PIETRO FIORENTINI S.p.A. is not liable for damage and/or malfunctions caused by installation in environments other than those permitted.

7.3 - CHECKS BEFORE INSTALLATION



RSE - RSV must be connected to an installation.

The installation site must be suitable for the safe use of the equipment.

The equipment installation area must have lighting that guarantees the operator good visibility during the installation phases.

Before installation, it must be ensured that:

- the installation compartment meets the provisions in force on safety and is away from any possible damage of mechanical origin, away from sources of heat or naked flames, in a dry place and protected from external agents;
- the utilities on the customer side are closed;
- there are no impediments that could hinder the installer's installation operations;
- the upstream and downstream pipes are at the same level and can bear the weight of the equipment;
- there are no stresses on the connections;
- the inlet and outlet connections of the equipment are clean and have not been damaged;
- mechanical stresses on the inlet and outlet connections are totally absent.

Installation	
Operator qualification	<ul style="list-style-type: none"> • Installer.
PPE required	<div style="display: flex; align-items: center;">  </div> <div style="background-color: #f4a460; padding: 5px; margin-top: 5px;">  WARNING! </div> <p>The PPE listed in this table is related to the risk associated with the equipment. For the PPE required to protect against risks associated with the workplace, installation or operating conditions, please refer to:</p> <ul style="list-style-type: none"> • the regulations in force in the country of installation; • any information provided by the Safety Manager at the installation facility.
Equipment required	Keys to fix inlet and outlet connections fittings/equipment.

Tab. 7.73.

7.4 - SPECIFIC SAFETY INSTRUCTIONS FOR THE INSTALLATION STEP

NOTICE!

The equipment is supplied with its battery packs already inserted and connected, therefore, once installed, it is ready for use.

WARNING!

Before proceeding with installation, make sure that the upstream and downstream valves installed on the line are shut off.

WARNING!

Installation may also take place in areas where there is a risk of explosion, which implies that all necessary prevention and protection measures have to be taken.
For these measures, please refer to the regulations in force at the place of installation.

WARNING!

Near the equipment, do not:

- use open flames (e.g. for welding operations);
- smoke.

WARNING!

Before connecting, make sure that:

- at least the portion of the system upstream of the equipment has been cut off and that, therefore, no flow of gas occurs during installation;
- the maximum system pressure is lower than the maximum pressure set for the equipment, which is fixed and equal to 0.5 relative bar.

WARNING!

Install the equipment with the indicator device in a horizontal position, not in direct contact with the wall and raised from the floor.

WARNING!

During the equipment installation:

- avoid mechanical stresses on its inlet/outlet connections;
- implement protective measures against electrostatic discharges.

ATTENTION!

If piping has been subsequently installed on the meter for pressure measurement, check the tightness of the relevant connection.

7.5 - INSTALLATION PROCEDURE

! NOTICE!

RSE - RSV operates only in an upright position.

Proceed as described in Tab.7.74 for the **installation of the meter (A)**:

Step	Action
1	Remove the 2 protection caps of the connection fittings (B), if still present.
	Place the meter in the adequately prepared compartment, in the section of the line used for it.
	<h3>! NOTICE!</h3> <p>The arrow on the top of the meter indicates the direction of the gas flow and therefore, the orientation of the meter within the relative compartment.</p>
2	Place the gaskets between the line fitting and the meter fitting.
	Connect the upstream and downstream pipes to the meter.
3	<h3>! NOTICE!</h3> <ul style="list-style-type: none"> • Use suitable fittings (if necessary) for the connection. • Tighten fittings to a torque not exceeding 110 N/m, using suitable hand tools (Ref. EN1359 for DN 25 and DN 32 fittings).
	Slowly charge the meter RSE - RSV with pressure and check the tightness of the connection fittings.
4	<h3>! NOTICE!</h3> <p>The shut-off valve, located on the system upstream of the meter, must be opened gradually to avoid damage to the meter's internal components.</p>
5	The meter is now ready for use.
6	If present, slowly open the valve immediately downstream of the meter.

Tab. 7.74.

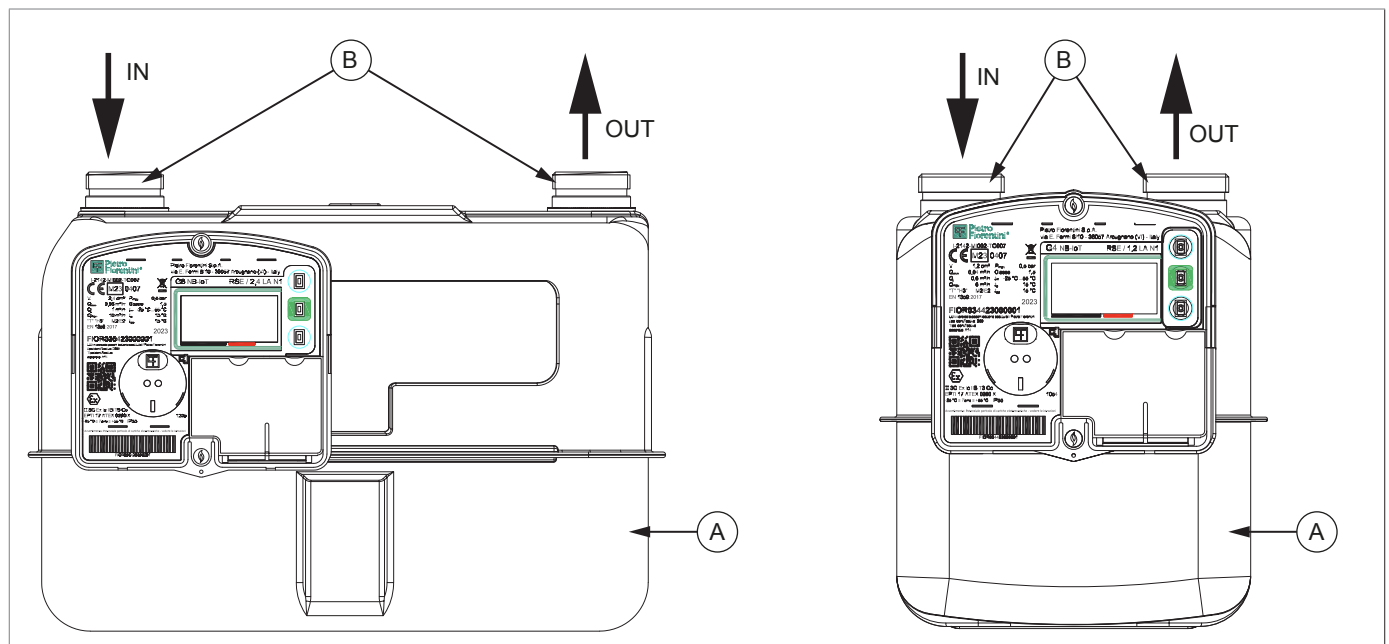

Fig. 7.9. Installation procedure

 **NOTICE!**

RSE - RSV is supplied with the shut-off valve in the 'open' state, immediately ready, after installation, to deliver and measure the gas flow.

 **ATTENTION!**

If piping has been subsequently installed on the meter for pressure measurement, check the tightness of the relevant connection.

8 - CONFIGURATION

8.1 - SAFETY REQUIREMENTS FOR CONFIGURATION

Configuration	
Operator qualification	<ul style="list-style-type: none"> Specialised technician. Installer.
PPE required	<div style="display: flex; align-items: center;">  </div> <div style="background-color: #f4a460; padding: 5px; margin-top: 5px;"> <p>WARNING!</p> </div> <p>The PPE listed in this table is related to the risk associated with the equipment. For the PPE required to protect against risks associated with the workplace, installation or operating conditions, please refer to:</p> <ul style="list-style-type: none"> the regulations in force in the country of installation; <u>any information provided by the Safety Manager at the installation facility.</u>

Tab. 8.75.

8.2 - EQUIPMENT CONFIGURATION

NOTICE!

Equipment configuration must be carried out by authorised and qualified personnel.

NOTICE!

The device field configuration can occur from the local port or remotely from CAS, always by means of the applied protocol, as specified in the provisions of standards series UNI/TS 11291.

8.2.1 - USING THE OPTICAL PROBE

The optical probe (available as an option) is fitted with a magnetic coupling on the meter.

Place the probe head in the appropriate slot on the front part of RSE - RSV with the cable facing downwards. The magnet and the groove will retain the device in place.

To activate communication on the optical port, simply activate the display by pressing the power button. The display will turn off automatically in case of local communication inactivity for more than 2 minutes.

8.3 - VERIFY CORRECT CONFIGURATION

The checks on the equipment are carried out automatically by the CAS.

8.4 - CONNECTING TO OTHER DEVICES

There is no equipment connection RSE - RSV with external devices.

8.5 - FIRMWARE UPDATE

In case of release of a new firmware version, notes that describe the changes made compared to the previous version are distributed.

NOTICE!

**The firmware update can easily be performed also remotely.
Contact PIETRO FIORENTINI S.p.A. for further details.**

9 - MAINTENANCE AND FUNCTIONAL CHECKS

9.1 - GENERAL WARNINGS

HAZARD!

- Maintenance work must be carried out by qualified personnel trained on safety in the workplace and authorised to carry out equipment-related activities.
- Repair or maintenance work not provided for in this manual may be carried out only if approved by PIETRO FIORENTINI S.p.A.. PIETRO FIORENTINI S.p.A. shall not be held liable for damage to persons or property resulting from operations other than those described herein or carried out in ways other than as indicated.

HAZARD!

Special maintenance:

- requires extensive and specialised knowledge of the machines, operations required, risks involved and correct procedures to operate safely;
- must be provided by qualified, trained and authorised technicians.

WARNING!

In case of doubt, do not perform any work.

Contact PIETRO FIORENTINI S.p.A. for the necessary clarifications.

NOTICE!

Before starting maintenance on the equipment, it is advisable to make sure that the authorised operator has:

- the necessary equipment;
- appropriate spare parts.

Operate as described in Tab.9.76. in case of anomalies detected in the equipment, which require its removal and replacement from the field:

Step	Action
1	Close the shut-off valve downstream of the equipment.
2	Close the shut-off valve upstream of the equipment.
3	Replace the equipment.

Tab. 9.76.

The equipment maintenance operations are divided, from an operational point of view, into two main categories:



Commissioning and maintenance operations

Routine maintenance	All those operations that the operator must preventively carry out to ensure proper operation of the device over time. <div style="border: 1px solid blue; padding: 5px; margin-top: 10px;">  NOTICE! The equipment does not require routine maintenance. </div>
Special maintenance	All those operations to be carried out by the operator as required by the equipment.

Tab. 9.77.

9.2 - SPECIAL MAINTENANCE

9.2.1 - REPLACING THE COMMUNICATION BATTERY PACK

Replacing the communication battery	
Operator qualification	<ul style="list-style-type: none"> Specialised technician. Maintenance Technician.
PPE required	 <div style="background-color: #f4a460; padding: 5px; margin-top: 5px;">  WARNING! </div> <p>The PPE listed in this table is related to the risk associated with the equipment. For the PPE required to protect against risks associated with the workplace, installation or operating conditions, please refer to:</p> <ul style="list-style-type: none"> the regulations in force in the country of installation; any information provided by the Safety Manager at the installation facility.
Equipment required	<ul style="list-style-type: none"> Useful tool to remove the screw cover seal; Phillips screwdriver DIN EN ISO 4757 TYPE H2 (type PH2); 2 screw cover seals supplied by Pietro Fiorentini (see Paragraph 11.3); 2 self-tapping screws M4x12 (see Paragraph 11.3).

Tab. 9.78.

The equipment has been designed to ensure in field replacement of the communication battery pack in case if the charge is flat.

The following relevant data are shown on the battery pack:

- communication battery pack identification code;
- identification type of the device;
- month and year of production (see following warning).

 **WARNING!**

The information on the month and year of production is part of the QR code on the battery. In the QR code there is an alphanumeric code where the last 4 digits represent the month and year of production, as shown in the example below::



V001000001P1121

(QR code with production date November 2021)

In Tab.9.79. each RSE - RSV model is associated with the identification type of the device and the identification code of the battery pack:

Model	Identifier type of the apparatus	Identifier code communication battery pack
GPRS	A14	D09
NB-IoT	A14	D09
RF169	A11	C01

Tab. 9.79.

HAZARD!

Batteries, especially if at end-of-life (exhausted), are dangerous and sensitive to shock, vibration and exposure to naked flames. Failure to comply with this document may lead to the risk of explosion, fire, harmful emissions which may have serious consequences for health.

ATTENTION!

Use only battery packs supplied by PIETRO FIORENTINI S.p.A.

ATTENTION!

All operations must be carried out:

- away from heat sources,
- in a place protected from bad weather
- as far as possible from water sources that could cause a reaction with the lithium contained inside the batteries.

ATTENTION!

Operators should not wear jewellery or metal ornaments (rings, necklaces, bracelets and earrings) that may come into contact with electronic components and/or battery terminals to avoid potential short circuits.

ATTENTION!

Fire extinguishers to be used in the event of a fire must be class D because they are effective in the presence of lithium.

ATTENTION!

The transport of the battery packs supplied by PIETRO FIORENTINI S.p.A. must be carried out using the original packaging, which complies with the current ADR regulations.

NOTICE!

Battery replacement must be managed in such a way as not to generate false alarms. Use the software procedure that allows you to temporarily disable the logging of fraud events and reset the estimated life meters of the communication battery pack.

If one of the following events occurs during the battery installation operations:

- battery falling to the ground;
- damage to the battery casing or swollen battery;
- battery overheating;

it is mandatory to dispose of the battery in accordance with the regulations in force (see paragraph 10.7.1) and replace it with new problem-free batteries (see paragraph 9.2.1).

For further information please contact the contact person of PIETRO FIORENTINI S.p.A.

Proceed as described in Tab.9.80. (referring to Fig.9.10.) to **replace the communication battery pack:**

Step	Action
1	Use the suitable tool to remove the 2 screw cover seals (A).
2	<p>Unscrew the 2 fixing screws (B) of the transparent cover (C) with the Phillips screwdriver and remove it from its seat.</p> <div style="border: 1px solid black; padding: 5px;"> <p>NOTICE!</p> <p>When the transparent front cover (C) is removed, a mechanical anti-tampering device will trigger a removal signal.</p> </div>

Step	Action
3	Open the door (D) that allows access to the communication battery compartment (E).
4	Disconnect the communication battery connector from its housing (F) and remove the battery from the compartment. ⚠ ATTENTION! Store the replaced communication battery in ADR compliant packaging.
5	Insert the 3-pin connector of the new communication battery into its housing (F), then close the door (D) of the battery compartment making sure it fits in properly. ! NOTICE! <ul style="list-style-type: none"> • The 3-pin connector of the battery pack is polarised so that it can only be inserted into the connector of the equipment corresponding to the correct polarity. • Ensure that when inserting the 3-pin connector, the cable with the positive (red) pole is pointing downwards. • Position the cables (G) so as to facilitate closing the door (D) without damaging them.
6	Insert the transparent cover (C) in its seat, checking that it is fully inserted, then tighten the 2 fixing screws (B) with the Phillips screwdriver. ! NOTICE! Tightening torque 1.3 Nm (minimum 1.2 Nm - maximum 1.4 Nm).
7	Insert the new 2 screw cover seals (A) making sure they are completely inserted in the corresponding hole.

Tab. 9.80.

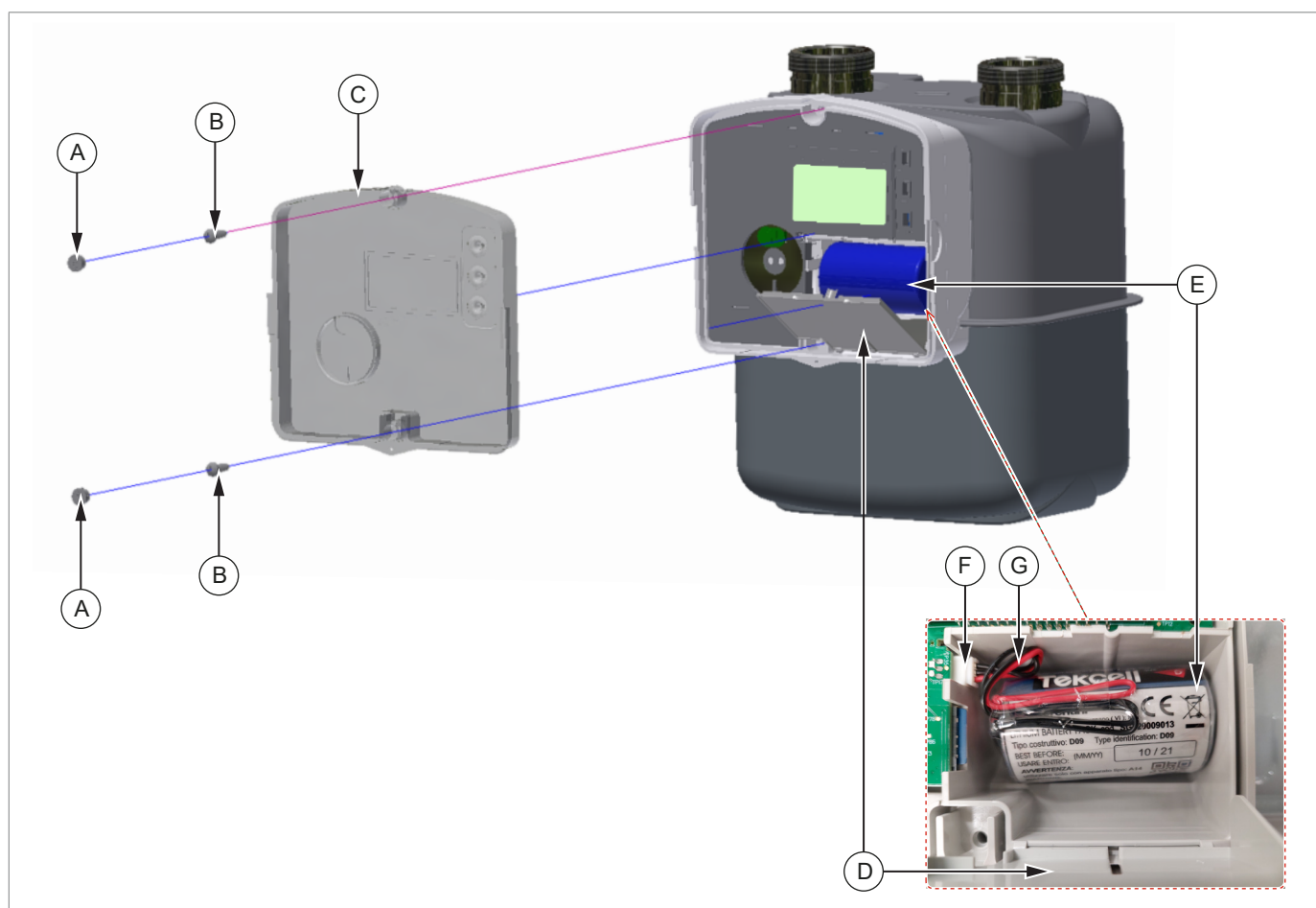



Fig. 9.10.

Replacing the communication battery pack

9.2.2 - SIM REPLACEMENT (GPRS AND NB-IOT VERSIONS ONLY)

SIM replacement	
Operator qualification	<ul style="list-style-type: none"> Specialised technician. Maintenance Technician.
PPE required	 <p>WARNING!</p> <p>The PPE listed in this table is related to the risk associated with the equipment. For the PPE required to protect against risks associated with the workplace, installation or operating conditions, please refer to:</p> <ul style="list-style-type: none"> the regulations in force in the country of installation; any information provided by the Safety Manager at the installation facility.
Equipment required	<ul style="list-style-type: none"> Useful tool to remove the screw cover seal; Phillips screwdriver DIN EN ISO 4757 TYPE H2 (type PH2); 2 screw cover seals supplied by Pietro Fiorentini (see Paragraph 11.3); 2 self-tapping screws M4x12 (see Paragraph 11.3).

Tab. 9.81.

ATTENTION!

All operations must be carried out:

- away from heat sources,
- in a place protected from bad weather
- as far as possible from water sources that could react when it comes into contact with the lithium contained inside the batteries, even accidentally.

ATTENTION!

Operators should not wear jewellery or metal ornaments (rings, necklaces, bracelets and earrings) that may come into contact with electronic components and/or battery terminals to avoid potential short circuits.

ATTENTION!

Fire extinguishers to be used in the event of a fire must be class D because they are effective in the presence of lithium.

Proceed as described in Tab.9.82. to **replace the SIM** (refer to Fig.9.11.):

Step	Action
1	Use the suitable tool to remove the 2 screw cover seals (A).
2	Unscrew the 2 fixing screws (B) of the transparent cover (C) with the Phillips screwdriver and remove it from its seat. <p>NOTICE!</p> <p>When the transparent front cover (C) is removed, a mechanical anti-tampering device will trigger a removal signal.</p>
3	Open the door (D) that allows access to the communication battery compartment (E).
4	<p>HAZARD!</p> <p>Batteries are dangerous and sensitive to shock, vibration and exposure to open flames. Failure to comply with this document may lead to the risk of explosion, fire, harmful emissions which may have serious consequences for health.</p>

Step	Action
5	Press on the SIM (H) to activate the push/pull extraction mechanism, then extract the SIM (H1) from its seat.
6	Insert the new SIM (H1) and press on the SIM itself (H) to activate the push/pull insertion mechanism.
7	Insert the connector of the communication battery into its housing (F), then close the door (D) of the battery compartment making sure it fits in properly. NOTICE! Position the cables (G) so as to facilitate closing the door (D) without damaging them.
8	Insert the transparent cover (C) in its seat, checking that it is fully inserted, then tighten the 2 fixing screws (B) with the Phillips screwdriver. NOTICE! Tightening torque 1.3 Nm (minimum 1.2 Nm - maximum 1.4 Nm).
9	Insert the new 2 screw cover seals (A) making sure they are completely inserted in the corresponding hole.

Tab. 9.82.

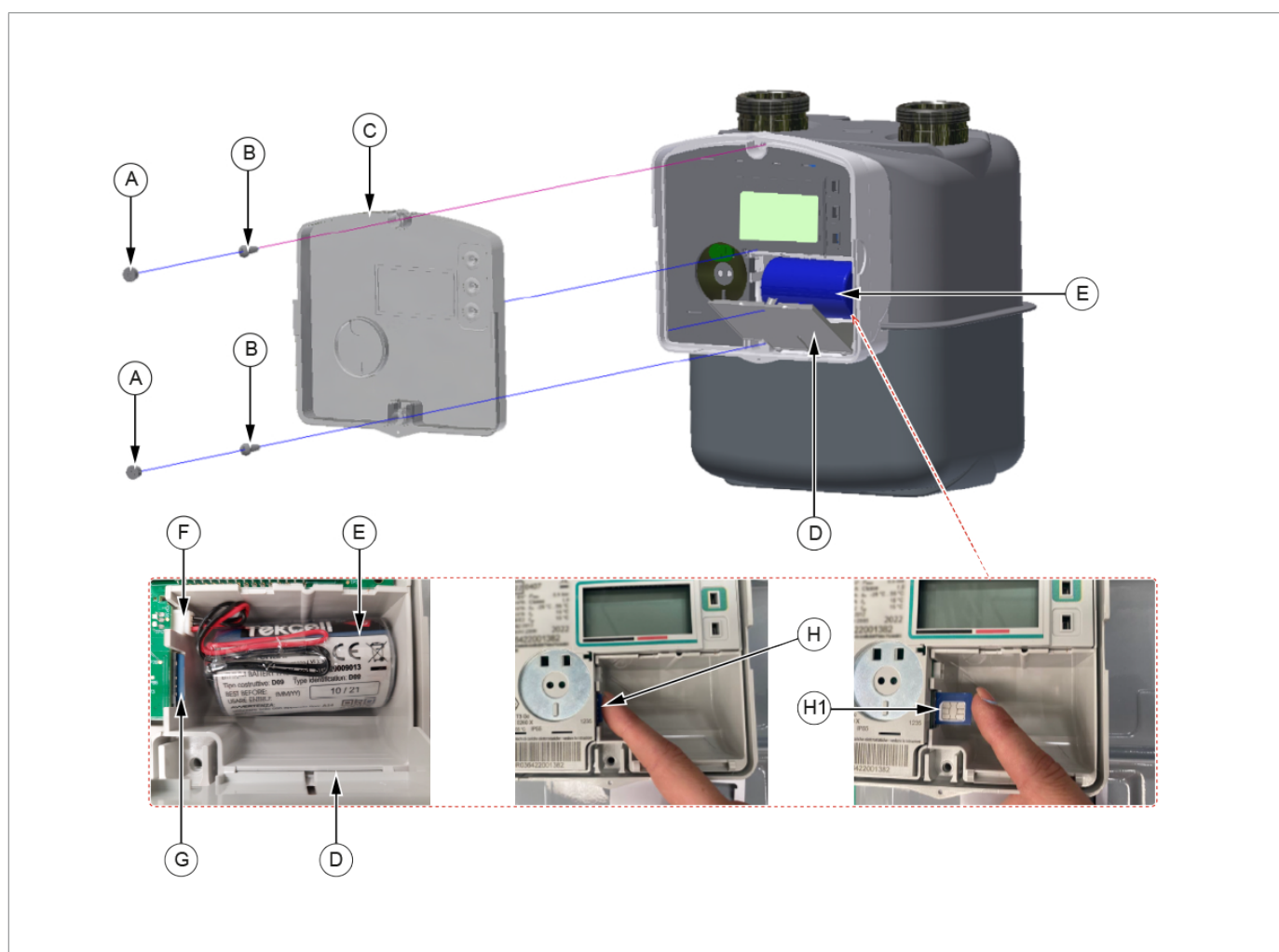

Fig. 9.11. SIM Replacement

9.3 - METROLOGICAL VERIFICATIONS IN THE LABORATORY

NOTICE!

Metrological verification must be carried out by authorised laboratories in accordance with applicable national laws and regulations.

The metrological verification of Diaphragm smart meter RSE - RSV is performed by comparing the counted volume, available through direct reading of the display, with the volume of air counted by the certified sample instrument of the laboratory test facility.

The Diaphragm smart meter RSE - RSV displays the converted totaliser at basic temperature conditions (V_b); the basic temperature value used for the conversion is indicated on the metrological plate (t_b). The volume marked by the sample instrument must be restored to the same thermodynamic conditions.

9.3.1 - REQUIREMENTS FOR SETTING UP THE TEST

Mandatory requirements:

- acclimatise the DUT (Device Under Test) to laboratory temperature for no less than 8 hours before it is metrologically verified;

NOTICE!

Failure to follow the acclimatisation procedure may result in an error in the measurement

- keep the climatic conditions unchanged for the duration of the test;
- test at a pressure of 10 mbar;
- Open/close all valves of the test system gradually in order to avoid sudden pressure surges;

NOTICE!

Failure to comply with this warning may impair the proper functioning of the DUT.

- check that the test system is perfectly tight before performing the metrological verification test;

NOTICE!

After checking the tightness of the test system, pass a minimum amount of air equal to 80 times the Cyclic Volume (V) and the maximum flow rate (Q_{max}) of the DUT to flush the meter internally. The values of Cyclic Volume V and Q_{max} are given in the rated data of the DUT.

- Verify that the measurement uncertainty of the test system is not greater than 1/3 of the maximum permissible error (MPE) as defined in MID 2014/32/EU.

9.3.2 - TEST PROCEDURE

 **NOTICE!**

Take into account the inherent error of the sample instrument in the calculation.

For the test, proceed as described in Tab.9.83:

Step	Action
1	Bring the test system under pressure (i.e.: upstream valve open and downstream valve closed).
2	Take the initial reading of the sample instrument totaliser ($V_{m_master_start}$) and record the air temperature value in Kelvin degrees with 2 decimal places (t_{air}).
3	Enable the display of the fourth decimal place of the converted totaliser log under basic conditions on the DUT.
4	Perform initial readout of the totaliser log ($V_{b_DUT_start}$).
5	Pass the volume of air, at the reference flow rate, according to the laboratory test procedure for metrological verification.
6	Take the final readout of the sample instrument totaliser ($V_{m_master_stop}$) and calculate the volume delta transited: $deltaV_{m_master} = V_{m_master_stop} - V_{m_master_start}$
7	Convert the $deltaV_{m_master}$ value at basic temperature conditions using the formula: $deltaV_{b_master} = deltaV_{m_master} * t_b / t_{air}$ where: $deltaV_{b_master}$ = Test volume converted at basic conditions; t_b = basic temperature. The value given is on the metrological plate of the DUT and converted to Kelvin degrees for calculation ($K = t_b [^{\circ}C] + 273.15$);
8	Take the final reading on the display of the DUT, the totaliser converted at basic conditions ($V_{b_DUT_stop}$) and calculate the volume delta transited: $deltaV_{b_DUT} = V_{b_DUT_stop} - V_{b_DUT_start}$
9	Compare the values $deltaV_{b_master}$ and $deltaV_{b_DUT}$ to calculate the percentage error of the measurement (E): $E = 100 * [(deltaV_{b_DUT} - deltaV_{b_master}) / deltaV_{b_master}]$

Tab. 9.83.

 **NOTICE!**

As an alternative to visually detecting the totaliser on the DUT's display, it is possible to use test software (based on the DLMS protocol) provided by PIETRO FIORENTINI S.p.A. that allows the value of the totaliser log to be read in high resolution via the DUT's optical communication port.

10 - UNINSTALLATION AND DISPOSAL

10.1 - GENERAL SAFETY WARNINGS

HAZARD!



Make sure that there are no potentially explosive ignition sources in the work area set up to uninstall and/or dispose of the equipment.

WARNING!

Before proceeding with uninstallation and disposal, make the equipment safe by disconnecting it from any power supply.

10.2 - QUALIFICATION OF THE OPERATORS IN CHARGE

Uninstallation

Operator qualification	<ul style="list-style-type: none"> Installer.
PPE required	<div style="display: flex; align-items: center;">  </div> <div style="background-color: #f96; padding: 5px; margin-top: 5px;">  WARNING! </div> <p>The PPE listed in this table is related to the risk associated with the equipment. For the PPE required to protect against risks associated with the workplace, installation or operating conditions, please refer to:</p> <ul style="list-style-type: none"> the regulations in force in the country of installation; any information provided by the Safety Manager at the installation facility.
Equipment required	Keys to fix inlet and outlet connections fittings/equipment.

Tab. 10.84.

10.3 - UNINSTALLATION

HAZARD!

The uninstalled meter may contain a residual amount of gas. To avoid the danger of explosion:

- thoroughly clean the meter with inert gas;
- Use a vehicle with an open or ventilated loading area for transport (if necessary).

To properly uninstall the equipment, proceed as specified in Tab. 10.85.:

Step	Action
1	Close the valves upstream and downstream of the equipment.
2	Disconnect the upstream and downstream pipes from the equipment by unscrewing the fittings with adequate hand tools.
3	Remove the equipment. <div style="border: 1px solid blue; padding: 5px; margin-top: 5px;">  NOTICE! Seal the valves upstream and downstream of the equipment if: <ul style="list-style-type: none"> closing the system; the equipment is not replaced immediately. </div>

Tab. 10.85.

10.4 - INFORMATION REQUIRED IN CASE OF NEW INSTALLATION

NOTICE!

Should the equipment be reused after uninstallation, refer to chapters: “Installation” and “Configuration”.

10.5 - STORAGE OF THE BATTERIES

NOTICE!

Refer to paragraph 6.7.1 to store the batteries.

10.6 - INFORMATION REQUIRED IN CASE OF RE-INSTALLATION

NOTICE!

Refer to chapter 7 “Installation” if the equipment is to be reused after uninstallation.

10.7 - DISPOSAL INFORMATION

NOTICE!

- Proper disposal prevents damage to humans and the environment and promotes the reuse of precious raw materials.
- Bear in mind that the regulations in force in the country of installation must be complied with.
- Illegal or improper disposal involves the application of the penalties provided for by the regulations in force in the country of installation.



When removing the device from the field, it must not be disposed of with normal waste. Dispose of the device pursuant to the provisions of It. Legislative Decree 14 March 2014, no. 49 “Implementation of directive 2012/19/EU on waste electric and electronic equipment (WEEE).

The equipment was manufactured with materials that can be recycled by specialised companies.

For proper disposal of the equipment, proceed as specified in Tab. 10.86.:

Step	Action
1	Set up a large work area free from obstacles where to safely dismantle the equipment.
2	Sort the various components by type of material for easier recycling through separate collection.
3	Send the materials obtained in Step 2 to a specialised company.

Tab. 10.86.

The equipment in any configuration consists of the materials described in Tab.10.87.:

Material	Disposal/recycling indications
Plastic	It must be dismantled and disposed of separately.
Steel	Disassemble and collect separately. It must be recycled through the specific collection centres.
Stainless steel	Disassemble and collect separately. It must be recycled through the specific collection centres.
Aluminium	Disassemble and collect separately. It must be recycled through the specific collection centres.
Electronic components	Disassemble and collect separately. It must be recycled through the specific collection centres.
Lithium batteries	Refer to paragraph 10.7.1 “Disposing of the batteries”.

Tab. 10.87.

! NOTICE!

The above materials refer to standard versions. Different materials can be provided for specific needs.

10.7.1 - DISPOSING OF THE BATTERIES

Proceed with disposal in compliance with the requirements:

- on transport and packaging in the chapter;
- of the legislation in force in the country of installation of the equipment.

! WARNING!



When disposing of the batteries, they must be removed from the equipment, as indicated in Directive 2006/66/EC art.12 paragraph 3.

The transport of the batteries to the intermediate treatment plants is not subject to the provisions of the ADR if the volume of each packaging containing the batteries does not exceed 450 litres.

! NOTICE!

Take steps to prevent any leakage of battery contents under normal transport conditions.

! NOTICE!

You can ship batteries and/or batteries for recycling or disposal under a partial exemption scheme, in accordance with special provision 636.

This exemption applies to lithium batteries/batteries of gross mass ≤ 500 g per unit.

10.7.1.1 - BATTERY REMOVAL

Upon disposal, the 2 non-rechargeable batteries must be removed from the device.

To remove the metrology battery (A), proceed as described in Tab.10.88 (referring to Fig.10.12.):

Step	Action
1	Proceed according to Steps 1-2 in Tab. 9.76. (see paragraph 9.2.1).
2	Break the metrological seal and the cover where all the metrological texts of the instrument are found.
3	Unscrew the 3 fixing screws (B) of the circuit board (C) to access the metrological battery compartment (A).
4	Unscrew the 2 fixing screws (D) of the retaining U-bolt to remove the battery.
5	 ATTENTION! The separate collection symbol for batteries and accumulators is indicated on the battery.

Tab. 10.88.

To remove the communication battery (E), proceed as described in Tab.10.89 (referring to Fig.10.12.):

Step	Action
1	Proceed according to Steps 1-2 in Tab. 9.76. (see paragraph 9.2.1).
2	Open the door (F) that allows access to the communication battery compartment (E).
3	 ATTENTION! The separate collection symbol for batteries and accumulators is indicated on the battery.

Tab. 10.89.

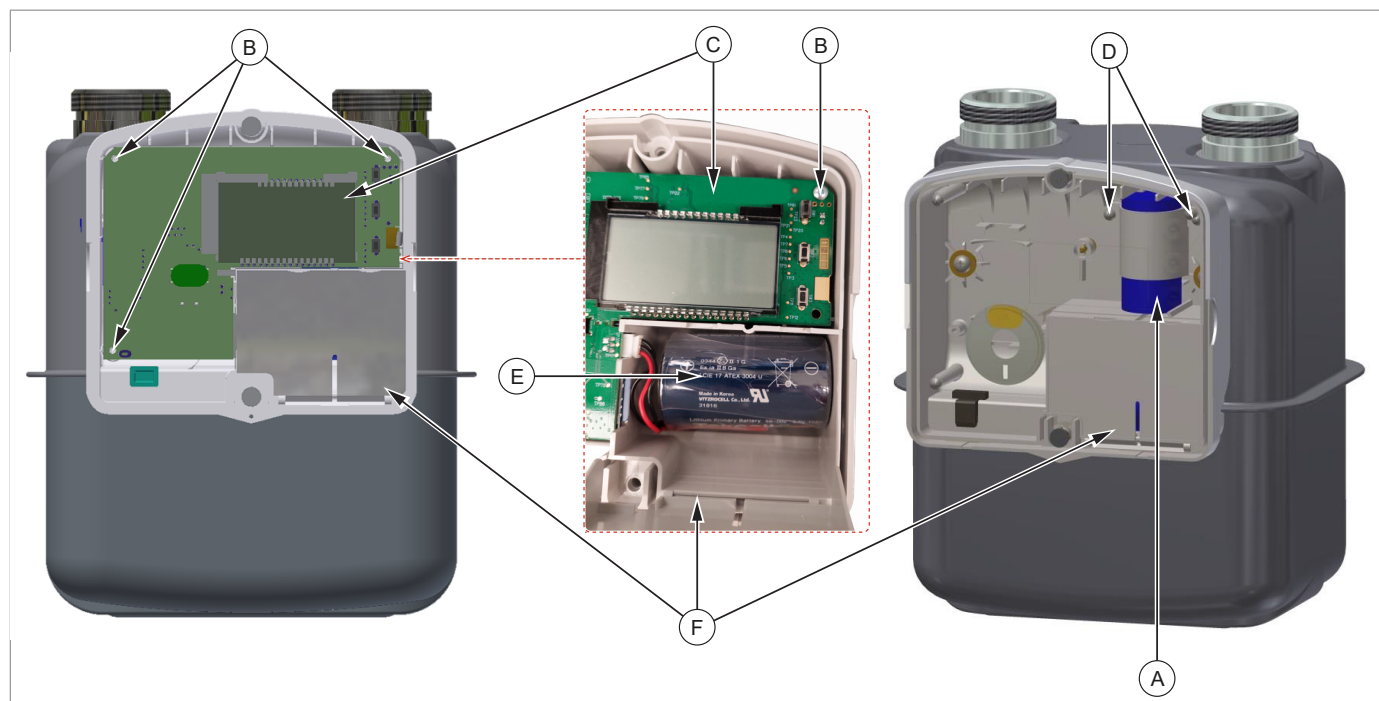

Fig. 10.12. Battery removal

10.7.1.2 - BATTERY PACKAGING

NOTICE!

The packages must be labelled in accordance with ADR, i.e. with a diamond shape on the side and code UN3090.



NOTICE!

The packages must bear the indication "LITHIUM BATTERIES FOR DISPOSAL" or "LITHIUM BATTERIES FOR RECYCLING".

The batteries that are removed from the equipment must be packed in such a way:

- to be protected from any damage due to transport and handling;
- to prevent any accidental movement;
- to prevent the terminals from bearing the weight of other elements;
- to be protected from short circuits.

For this purpose, the original packaging or alternatively, packaging compliant with the ADR regulations, can be used.

If batteries not removed from the equipment but still inside it are transported, the packaging may not be approved but must still be:

- sufficiently robust and able to contain and protect the equipment;
- constructed in such a way as to prevent the equipment from operating accidentally during transport.

11 - RECOMMENDED SPARE PARTS

11.1 - GENERAL WARNINGS

NOTICE!

If spare parts not recommended are used, PIETRO FIORENTINI S.p.A. their declared performance cannot be guaranteed.

It is recommended to use original spare parts PIETRO FIORENTINI S.p.A.

PIETRO FIORENTINI S.p.A. shall not be held liable for any damage caused by using non-original parts.

11.2 - HOW TO REQUEST SPARE PARTS

NOTICE!

For specific information, please refer to the sales network of PIETRO FIORENTINI S.p.A.

11.3 - SPARE PARTS LIST

NOTICE!

Spare parts are unambiguously identified by:

- a position specified in the assembly drawing of the equipment (Fig.11.13.);
- an identification code that associates the position with the component (Tab.11.90).

Reference to the spare parts order codes:

Pos.	Code	Component
1	SG120070819	Screw cover seal
2	SG340011327	Self-tapping screw M4x12
3	SG120070801	Plastic enclosure

Tab. 11.90.

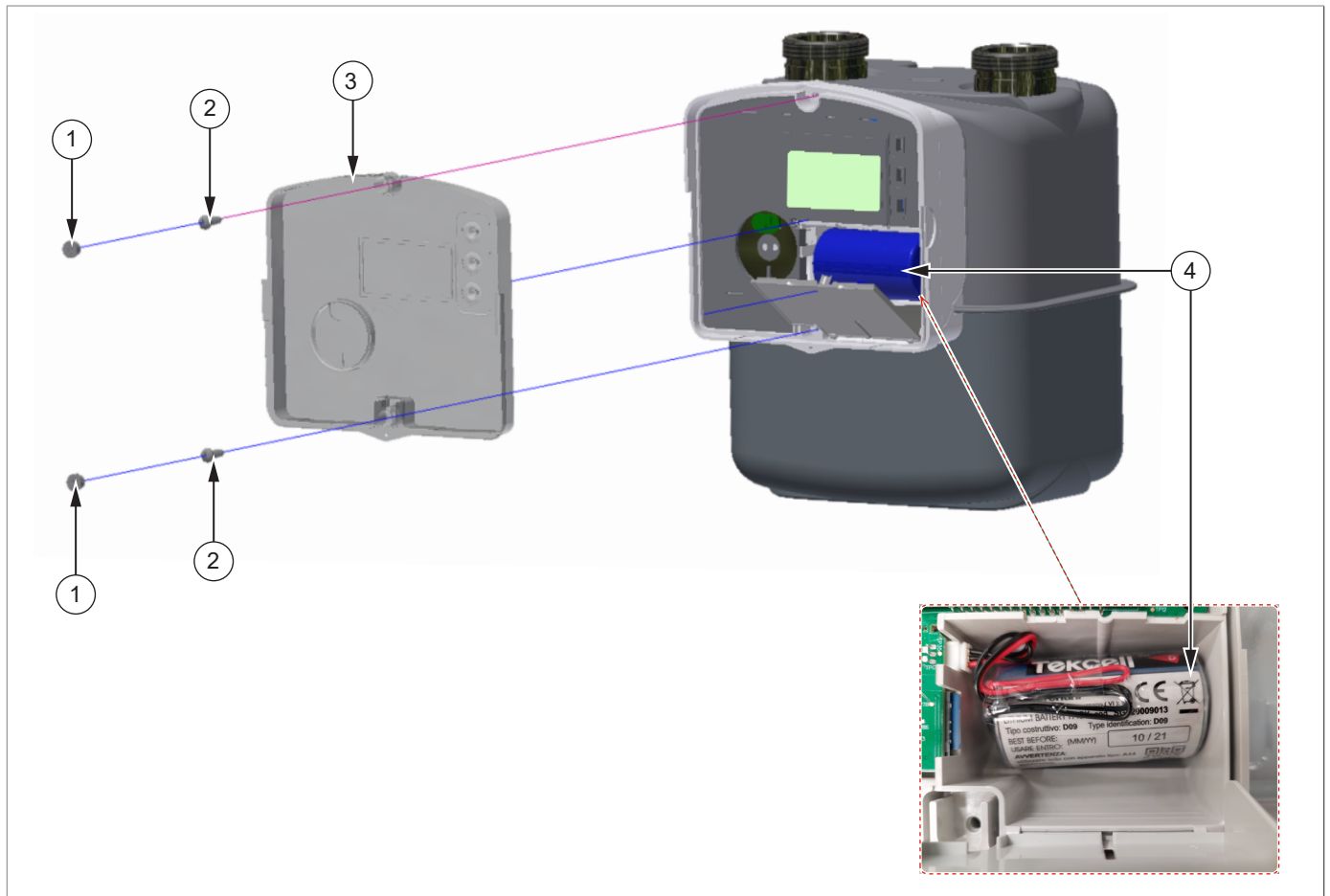

Fig. 11.13. Spare parts

11.4 - PUTTING BACK BATTERIES

Reference to battery order codes (Pos. 4 - Fig. 11.13.) spare parts:

Model	Replacement battery pack code	Identifier code communication battery pack
GPRS	SG220009013	D09
NB-IoT	SG220009013	D09
RF169	SG220009012	C01

Tab. 11.91.

TM0081ENG



**Pietro
Fiorentini**